

BARITONE

CASEGOODS SPEC GUIDE

Traditional Wood Veneer • May 2019



**OFG** UNICOR  
OFFICE  
FURNITURE  
GROUP

## BARITONE • L-Unit 68" Desk – Right Hand Return

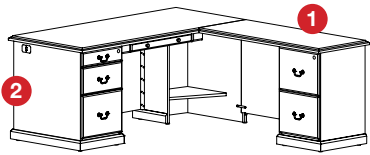

Footprint: 68"w x 79"d x 30"h

DESCRIPTION	PART NUMBER	WIDTH	DEPTH	HEIGHT	SHIP WGT
1. Desk Extension, Right Hand Return, Pedestal with Two File Drawers on Right	BT4921EXRH_ _	49"	20 3/4"	30"	232 lbs
2. Desk - Single Pedestal with Pencil, Box, File Drawer on Left Side Open Shelves on Right with Center Pencil Drawer	BT6830DKLH_ _	66"	30"	30"	385 lbs
<b>CONFIGURATION TOTALS</b>					617 lbs

## BARITONE • L-Unit 68" Desk – Left Hand Return

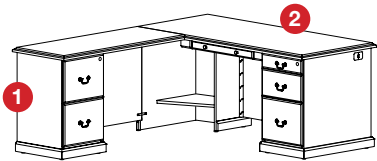

Footprint: 68"w x 79"d x 30"h

DESCRIPTION	PART NUMBER	WIDTH	DEPTH	HEIGHT	SHIP WGT
1. Desk Extension, Left Hand Return, Pedestal with Two File Drawers on Left	BT4921EXLH_ _	49"	20 3/4"	30"	232 lbs
2. Desk - Single Pedestal with Pencil, Box, File Drawer on Right Side Open Shelves on Left with Center Pencil Drawer	BT6830DKRH_ _	68"	30"	30"	385 lbs
<b>CONFIGURATION TOTALS</b>					617 lbs

- 1/32" veneer is grade "A" Cherry, plain-sliced, bookmatched without knots or objectionable grain distortion.
- All exposed substrate edges are solid cherry hardwood.
- Drawer slides are 100 pound rated, ball bearing slides with full extension.
- All file drawers have central locking mechanisms and feature adaptable rails for letter and legal filing. Lateral file drawers allow front-to-back vertical filing and side-to-side lateral filing.
- Wire management grommets are located on the sides of desks.

### TO ORDER:

Select the product number and add finish color.

Finish Color:

CH = Cherry Finish

MH = Mahogany Finish

WN = Walnut Finish

For example: BT6830DKCH

Product # BT6830DK Finish Color - CH = Cherry Finish

Baritone product numbers are comprised of alpha and numeric characters. This number indicates product line, size, product options and finish color.

Note: The workstations presented above are suggestions to show the versatility of the groupings. Each grouping is accompanied by a list of the furniture represented in the drawing. You can make your own plans by using different items listed in this catalog.

Pricing shown is discounted to match GSA. Additional discounting available for large quantities. Contact your sales rep for more information.

Product dimensions shown in approximate inches.

## BARITONE • L-Unit 68" Desk with Transaction Counter – Right Hand Return

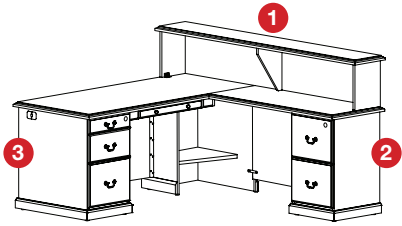

Footprint: 68"w x 79"d x 44 1/2"h

DESCRIPTION	PART NUMBER	WIDTH	DEPTH	HEIGHT	SHIP WGT
1. Transaction Counter	BT7912TC_ _	79"	12"	14 1/2"	203 lbs
2. Desk Extension, Right Return, Pedestal with Two File Drawers on Right	BT4921EXRH_ _	49"	20 3/4"	30"	232 lbs
3. Desk - Single Pedestal with Pencil, Box, File Drawer on Left Side Open Shelves on Right with Center Pencil Drawer	BT6830DKLH_ _	68"	30"	30"	385 lbs
<b>CONFIGURATION TOTALS</b>					820 lbs

- 1/32" veneer is grade "A" Cherry, plain-sliced, bookmatched without knots or objectionable grain distortion.
- All exposed substrate edges are solid cherry hardwood.
- Drawer slides are 100 pound rated, ball bearing slides with full extension.
- All file drawers have central locking mechanisms and feature adaptable rails for letter and legal filing. Lateral file drawers allow front-to-back vertical filing and side-to-side lateral filing..
- Wire management grommets are located on the sides of desks.

## BARITONE • L-Unit 68" Desk with Transaction Counter – Left Hand Return

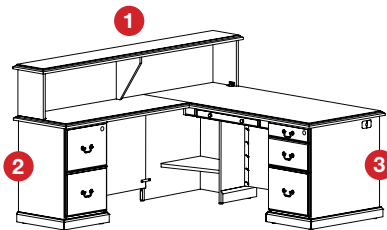

Footprint: 68"w x 79"d x 44 1/2"h

DESCRIPTION	PART NUMBER	WIDTH	DEPTH	HEIGHT	SHIP WGT
1. Transaction Counter	BT7912TC_ _	79"	12"	14 1/2"	203 lbs
2. Desk Extension, Left Return, Pedestal with Two File Drawers on Right	BT4921EXLH_ _	49"	20 3/4"	30"	232 lbs
3. Desk - Single Pedestal with Pencil, Box, File Drawer on Right Side Open Shelves on Right with Center Pencil Drawer	BT6830DKRH_ _	68"	30"	30"	385 lbs
<b>CONFIGURATION TOTALS</b>					820 lbs

### TO ORDER:

Select the product number and add finish color.

Finish Color:

- CH = Cherry Finish
- MH = Mahogany Finish
- WN = Walnut Finish

For example: BT6830DKCH

Product # BT6830DK Finish Color - CH = Cherry Finish

Baritone product numbers are comprised of alpha and numeric characters. This number indicates product line, size, product options and finish color.

Note: The workstations presented above are suggestions to show the versatility of the groupings. Each grouping is accompanied by a list of the furniture represented in the drawing. You can make your own plans by using different items listed in this catalog.

Pricing shown is discounted to match GSA. Additional discounting available for large quantities. Contact your sales rep for more information.

Product dimensions shown in approximate inches.

## BARITONE • L-Unit 72" Desk – Right Hand Return with Hutch

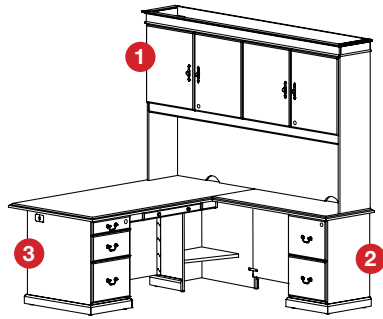

Footprint: 72"w x 85"d x 82"h

DESCRIPTION	PART NUMBER	WIDTH	DEPTH	HEIGHT	SHIP WGT
1. Upper Hutch, Four Solid Doors with 33" Task Light	BT8515HTUS_ _	85"	14 1/2"	54"	375 lbs
2. Desk Extension, Right Return, Pedestal with Two File Drawers on Right	BT4921EXRH_ _	49"	20 3/4"	30"	232 lbs
3. Desk - Single Pedestal with Pencil, Box, File Drawer on Left Side Open Shelves on Right with Center Pencil Drawer	BT7236DKLH_ _	72"	36"	30"	417 lbs
<b>CONFIGURATION TOTALS</b>					1,024 lbs

## BARITONE • L-Unit 72" Desk – Left Hand Return with Hutch

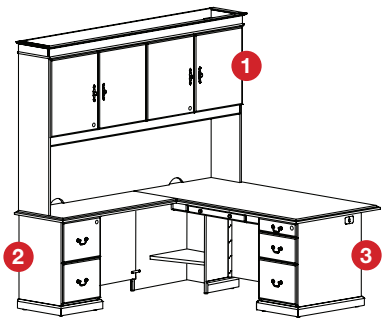

Footprint: 72"w x 85"d x 82"h

DESCRIPTION	PART NUMBER	WIDTH	DEPTH	HEIGHT	SHIP WGT
1. Upper Hutch, Four Solid Doors with 33" Task Light	BT8515HTUS_ _	85"	14 1/2"	54"	375 lbs
2. Desk Extension, Left Return, Pedestal with Two File Drawers on Left	BT4921EXLH_ _	49"	20 3/4"	30"	232 lbs
3. Desk - Single Pedestal with Pencil, Box, File Drawer on Right Side Open Shelves on Left with Center Pencil Drawer	BT7236DKRH_ _	72"	36"	30"	417 lbs
<b>CONFIGURATION TOTALS</b>					1,024 lbs

- 1/32" veneer is grade "A" Cherry, plain-sliced, bookmatched without knots or objectionable grain distortion.
- All exposed substrate edges are solid cherry hardwood.
- Drawer slides are 100 pound rated, ball bearing slides with full extension.
- All file drawers have central locking mechanisms and feature adaptable rails for letter and legal filing. Lateral file drawers allow front-to-back vertical filing and side-to-side lateral filing.
- Wire management grommets are located on the sides of desks.

### TO ORDER:

Select the product number and add finish color.

Finish Color:

CH = Cherry Finish

MH = Mahogany Finish

WN = Walnut Finish

For example: BT6830DKCH

Product # BT6830DK Finish Color - CH = Cherry Finish

Baritone product numbers are comprised of alpha and numeric characters. This number indicates product line, size, product options and finish color.

Note: The workstations presented above are suggestions to show the versatility of the groupings. Each grouping is accompanied by a list of the furniture represented in the drawing. You can make your own plans by using different items listed in this catalog.

Pricing shown is discounted to match GSA. Additional discounting available for large quantities. Contact your sales rep for more information.

Product dimensions shown in approximate inches.



## BARITONE • U-Unit 68" Desk – Right Hand Return

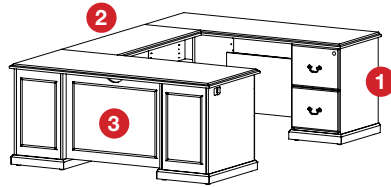

Footprint: 68"w x 96"d x 30"h

DESCRIPTION	PART NUMBER	WIDTH	DEPTH	HEIGHT	SHIP WGT
1. Credenza - Pedestal with Two File Drawers on Right Side Open Shelves on Left Side	BT6824CROCKH2F_ _	68"	24"	30"	205 lbs
2. Extension Bridge	BT4221BR_ _	42"	20 3/4"	30"	118 lbs
3. Desk - Single Pedestal with Pencil, Box, File Drawer on Left Side Open Shelves on Right	BT6830DKLH_ _	68"	30"	30"	385 lbs
<b>CONFIGURATION TOTALS</b>					708 lbs

- 1/32" veneer is grade "A" Cherry, plain-sliced, bookmatched without knots or objectionable grain distortion.
- All exposed substrate edges are solid cherry hardwood.
- Drawer slides are 100 pound rated, ball bearing slides with full extension.
- All file drawers have central locking mechanisms and feature adaptable rails for letter and legal filing. Lateral file drawers allow front-to-back vertical filing and side-to-side lateral filing.
- Wire management grommets are located on the sides of desks.

## BARITONE • U-Unit 68" Desk – Left Hand Return

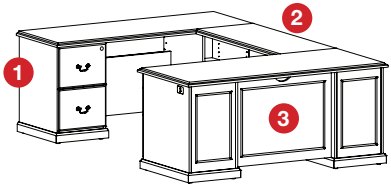

Footprint: 68"w x 96"d x 30"h

DESCRIPTION	PART NUMBER	WIDTH	DEPTH	HEIGHT	SHIP WGT
1. Credenza - Pedestal with Two File Drawers on Left Side Open Shelves on Right Side	BT6824CR2FKHOC_ _	68"	24"	30"	205 lbs
2. Extension Bridge	BT4221BR_ _	42"	20 3/4"	30"	118 lbs
3. Desk - Single Pedestal with Pencil, Box, File Drawer on Right Side Open Shelves on Left	BT6830DKRH_ _	68"	30"	30"	385 lbs
<b>CONFIGURATION TOTALS</b>					708 lbs

### TO ORDER:

Select the product number and add finish color.

Finish Color:

- CH = Cherry Finish
- MH = Mahogany Finish
- WN = Walnut Finish

For example: BT6830DKCH

Product # BT6830DK Finish Color - CH = Cherry Finish

Baritone product numbers are comprised of alpha and numeric characters. This number indicates product line, size, product options and finish color.

Note: The workstations presented above are suggestions to show the versatility of the groupings. Each grouping is accompanied by a list of the furniture represented in the drawing. You can make your own plans by using different items listed in this catalog.

Pricing shown is discounted to match GSA. Additional discounting available for large quantities. Contact your sales rep for more information.

Product dimensions shown in approximate inches.

## BARITONE • U-Unit 68" Desk – Right Hand Return With Hutch

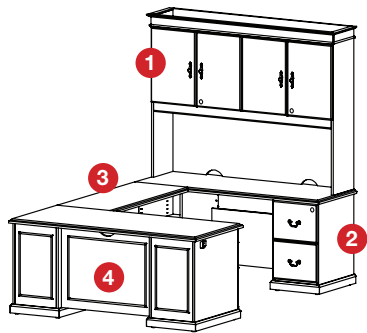

Footprint: 68"w x 96"d x 82"h

DESCRIPTION	PART NUMBER	WIDTH	DEPTH	HEIGHT	SHIP WGT
1. Upper Hutch, Four Solid Doors with Task Light	BT6815HTUS_ _	68"	14 1/2"	52"	298 lbs
2. Credenza - Pedestal with Two File Drawers on Right Side Open Shelved on Left Side	BT6824CROCKH2F_ _	68"	24"	30"	205 lbs
3. Extension Bridge	BT4221BR_ _	42"	20 3/4"	30"	118 lbs
4. Desk - Single Pedestal with Pencil, Box, File Drawer on Left Side Open Shelves on Right with Center Pencil Drawer	BT6830DKLH_ _	68"	30"	30"	385 lbs
<b>CONFIGURATION TOTALS</b>					1,006 lbs

- 1/32" veneer is grade "A" Cherry, plain-sliced, bookmatched without knots or objectionable grain distortion.
- All exposed substrate edges are solid cherry hardwood.
- Drawer slides are 100 pound rated, ball bearing slides with full extension.
- All file drawers have central locking mechanisms and feature adaptable rails for letter and legal filing. Lateral file drawers allow front-to-back vertical filing and side-to-side lateral filing.
- Wire management grommets are located on the sides of desks.

## BARITONE • U-Unit 68" Desk – Left Hand Return With Hutch

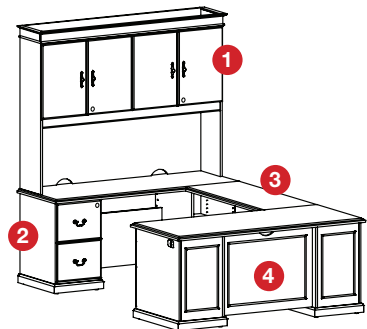

Footprint: 68"w x 96"d x 82"h

DESCRIPTION	PART NUMBER	WIDTH	DEPTH	HEIGHT	SHIP WGT
1. Upper Hutch, Four Solid Doors with Task Light	BT6815HTUS_ _	68"	14 1/2"	52"	298 lbs
2. Credenza - Pedestal with Two File Drawers on Left Side Open Shelved on Right Side	BT6824CR2FKHOC_ _	68"	24"	30"	205 lbs
3. Extension Bridge	BT4221BR_ _	42"	20 3/4"	30"	118 lbs
4. Desk - Single Pedestal with Pencil, Box, File Drawer on Right Side Open Shelves on Left with Center Pencil Drawer	BT6830DKRH_ _	68"	30"	30"	385 lbs
<b>CONFIGURATION TOTALS</b>					1,006 lbs

### TO ORDER:

Select the product number and add finish color.

Finish Color:

CH = Cherry Finish

MH = Mahogany Finish

WN = Walnut Finish

For example: BT6830DKCH

Product # BT6830DK Finish Color - CH = Cherry Finish

Baritone product numbers are comprised of alpha and numeric characters. This number indicates product line, size, product options and finish color.

Note: The workstations presented above are suggestions to show the versatility of the groupings. Each grouping is accompanied by a list of the furniture represented in the drawing. You can make your own plans by using different items listed in this catalog.

Pricing shown is discounted to match GSA. Additional discounting available for large quantities. Contact your sales rep for more information.

Product dimensions shown in approximate inches.

## BARITONE • U-Unit 68" Desk – Right Hand Return with Glass Bookcase

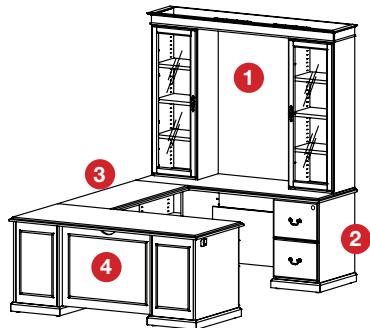

Footprint: 68"w x 96"d x 82"h

DESCRIPTION	PART NUMBER	WIDTH	DEPTH	HEIGHT	SHIP WGT
1. Upper Bookcase with Glass Doors and 33" Light Bridge	BT6815BCUGLBG_ _	68"	14 1/2"	54"	360 lbs
2. Credenza - Pedestal with Two File Drawers on Right Side Open Shelved on Left Side	BT6824CROCKH2F_ _	68"	24"	30"	205 lbs
3. Extension Bridge	BT4221BR_ _	42"	20 3/4"	30"	118 lbs
4. Desk - Single Pedestal with Pencil, Box, File Drawer on Left Side Open Shelves on Right with Center Pencil Drawer	BT6830DKLH_ _	68"	30"	30"	385 lbs
<b>CONFIGURATION TOTALS</b>					1,068 lbs

- 1/32" veneer is grade "A" Cherry, plain-sliced, bookmatched without knots or objectionable grain distortion.
- All exposed substrate edges are solid cherry hardwood.
- Drawer slides are 100 pound rated, ball bearing slides with full extension.
- All file drawers have central locking mechanisms and feature adaptable rails for letter and legal filing. Lateral file drawers allow front-to-back vertical filing and side-to-side lateral filing.
- Wire management grommets are located on the sides of desks.

## BARITONE • U-Unit 68" Desk – Left Hand Return with Glass Bookcase

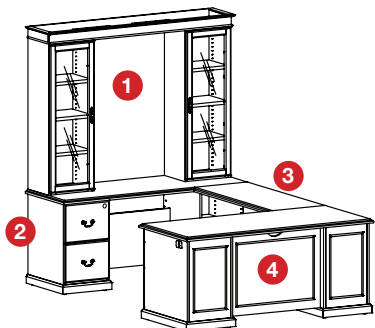

Footprint: 68"w x 96"d x 82"h

DESCRIPTION	PART NUMBER	WIDTH	DEPTH	HEIGHT	SHIP WGT
1. Upper Bookcase with Glass Doors and 33" Light Bridge	BT6815BCUGLBG_ _	68"	14 1/2"	54"	360 lbs
2. Credenza - Pedestal with Two File Drawers on Left Side Open Shelved on Right Side	BT6824CR2FKHOC_ _	68"	24"	30"	205 lbs
3. Extension Bridge	BT4221BR_ _	42"	20 3/4"	30"	118 lbs
4. Desk - Single Pedestal with Pencil, Box, File Drawer on Right Side Open Shelves on Left with Center Pencil Drawer	BT6830DKRH_ _	68"	30"	30"	385 lbs
<b>CONFIGURATION TOTALS</b>					1,068 lbs

### TO ORDER:

Select the product number and add finish color.

Finish Color:

- CH = Cherry Finish
- MH = Mahogany Finish
- WN = Walnut Finish

For example: BT6830DKCH

Product # BT6830DK Finish Color - CH = Cherry Finish

Baritone product numbers are comprised of alpha and numeric characters. This number indicates product line, size, product options and finish color.

Note: The workstations presented above are suggestions to show the versatility of the groupings. Each grouping is accompanied by a list of the furniture represented in the drawing. You can make your own plans by using different items listed in this catalog.

Pricing shown is discounted to match GSA. Additional discounting available for large quantities. Contact your sales rep for more information.

Product dimensions shown in approximate inches.

## BARITONE • U-Unit 72" Desk – Left Hand Return

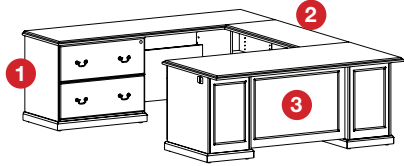

Footprint: 85"w x 102"d x 30"h

DESCRIPTION	PART NUMBER	WIDTH	DEPTH	HEIGHT	SHIP WGT
1. Credenza - 2-Drawer Lateral File on Left Side Open Shelves Right Side	BT8524CR2LKHOC__	85"	24"	30"	255 lbs
2. Extension Bridge	BT4221BR__	42"	20 3/4"	30"	118 lbs
3. Desk - Single Pedestal with Pencil, Box, File Drawer on Right Side Open Shelves on Left with Center Pencil Drawer	BT7236DKRH__	72"	36"	30"	417 lbs
<b>CONFIGURATION TOTALS</b>					790 lbs

- 1/32" veneer is grade "A" Cherry, plain-sliced, bookmatched without knots or objectionable grain distortion.
- All exposed substrate edges are solid cherry hardwood.
- Drawer slides are 100 pound rated, ball bearing slides with full extension.
- All file drawers have central locking mechanisms and feature adaptable rails for letter and legal filing. Lateral file drawers allow front-to-back vertical filing and side-to-side lateral filing.
- Wire management grommets are located on the sides of desks.

## BARITONE • U-Unit 72" Desk – Left Hand Return

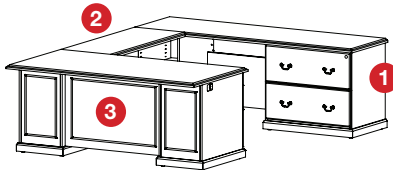

Footprint: 85"w x 102"d x 30"h

DESCRIPTION	PART NUMBER	WIDTH	DEPTH	HEIGHT	SHIP WGT
1. Credenza - 2-Drawer Lateral File on Left Side Open Shelves Right Side	BT8524CROCKH2L__	85"	24"	30"	255 lbs
2. Extension Bridge	BT4221BR__	42"	20 3/4"	30"	118 lbs
3. Desk - Single Pedestal with Pencil, Box, File Drawer on Right Side Open Shelves on Left with Center Pencil Drawer	BT7236DKLH__	72"	36"	30"	417 lbs
<b>CONFIGURATION TOTALS</b>					790 lbs

### TO ORDER:

Select the product number and add finish color.

Finish Color:

CH = Cherry Finish

MH = Mahogany Finish

WN = Walnut Finish

For example: BT6830DKCH

Product # BT6830DK Finish Color - CH = Cherry Finish

Baritone product numbers are comprised of alpha and numeric characters. This number indicates product line, size, product options and finish color.

Note: The workstations presented above are suggestions to show the versatility of the groupings. Each grouping is accompanied by a list of the furniture represented in the drawing. You can make your own plans by using different items listed in this catalog.

Pricing shown is discounted to match GSA. Additional discounting available for large quantities. Contact your sales rep for more information.

Product dimensions shown in approximate inches.



## BARITONE • U-Unit 72" Desk – Right Hand Return with Hutch

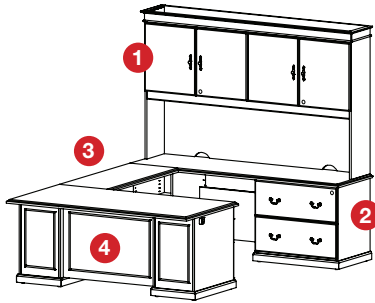

Footprint: 85"w x 102"d x 82"h

Note: 49" Extension Bridge  
BT4921BR\_\_ can be substituted to  
allow more room between the desk and  
credenza.

DESCRIPTION	PART NUMBER	WIDTH	DEPTH	HEIGHT	SHIP WGT
1. Upper Hutch, Four Solid Doors with Task Light	BT8515HTUS__	85"	14 1/2"	52"	375 lbs
2. Credenza - 2-Drawer Lateral File on Right Side Open Shelves Left Side	BT8524CROCKH2L__	85"	24"	30"	255 lbs
3. Extension Bridge	BT4221BR__	42"	20 3/4"	30"	118 lbs
4. Desk - Single Pedestal with Pencil, Box, File Drawer on Left Side Open Shelves on Right with Center Pencil Drawer	BT7236DKLH__	72"	36"	30"	417 lbs
<b>CONFIGURATION TOTALS</b>					1,165 lbs

- 1/32" veneer is grade "A" Cherry, plain-sliced, bookmatched without knots or objectionable grain distortion.
- All exposed substrate edges are solid cherry hardwood.
- Drawer slides are 100 pound rated, ball bearing slides with full extension.
- All file drawers have central locking mechanisms and feature adaptable rails for letter and legal filing. Lateral file drawers allow front-to-back vertical filing and side-to-side lateral filing.
- Wire management grommets are located on the sides of desks.

## BARITONE • U-Unit 72" Desk – Left Hand Return with Hutch

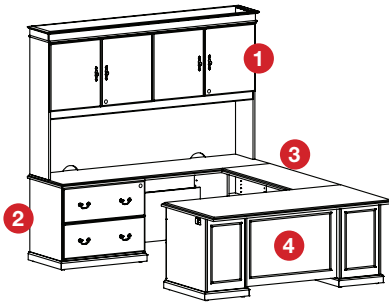

Footprint: 85"w x 102"d x 82"h

Note: 49" Extension Bridge  
BT4921BR\_\_ can be substituted to  
allow more room between the desk and  
credenza.

DESCRIPTION	PART NUMBER	WIDTH	DEPTH	HEIGHT	SHIP WGT
1. Upper Hutch, Four Solid Doors with Task Light	BT8515HTUS__	85"	14 1/2"	52"	375 lbs
2. Credenza - 2-Drawer Lateral File on Left Side Open Shelves Right Side	BT8524CR2LKHOC__	85"	24"	30"	255 lbs
3. Extension Bridge	BT4221BR__	42"	20 3/4"	30"	118 lbs
4. Desk - Single Pedestal with Pencil, Box, File Drawer on Right Side Open Shelves on Left with Center Pencil Drawer	BT7236DKRH__	72"	36"	30"	417 lbs
<b>CONFIGURATION TOTALS</b>					1,165 lbs

### TO ORDER:

Select the product number and add finish color.

Finish Color:

- CH = Cherry Finish
- MH = Mahogany Finish
- WN = Walnut Finish

For example: BT6830DKCH

Product # BT6830DK Finish Color -  
CH = Cherry Finish

Baritone product numbers are comprised of alpha and numeric characters. This number indicates product line, size, product options and finish color.

Note: The workstations presented above are suggestions to show the versatility of the groupings. Each grouping is accompanied by a list of the furniture represented in the drawing. You can make your own plans by using different items listed in this catalog.

Pricing shown is discounted to match GSA. Additional discounting available for large quantities. Contact your sales rep for more information.

Product dimensions shown in approximate inches.

**BARITONE • U-Unit 72" Desk – Right Hand Return with Open Bookcase**

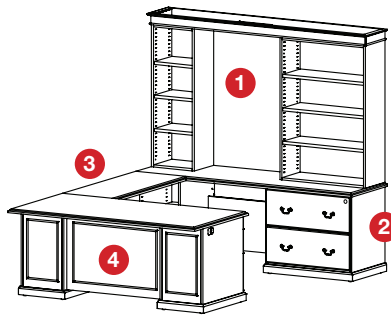

DESCRIPTION	PART NUMBER	WIDTH	DEPTH	HEIGHT	SHIP WGT
1. Upper Bookcase, Double Open Shelves Right, Single Shelves Left with 33" Light Bridge	BT8515BCU1OLB2O_ _	85"	14 1/2"	52"	275 lbs
2. Credenza - 2-Drawer Lateral File on Right Side Open Shelves Left Side	BT8524CROCKH2L_ _	85"	24"	30"	255 lbs
3. Extension Bridge	BT4221BR_ _	42"	20 3/4"	30"	118 lbs
4. Desk - Single Pedestal with Pencil, Box, File Drawer on Left Side Open Shelves on Right with Center Pencil Drawer	BT7236DKLH_ _	72"	36"	30"	417 lbs
<b>CONFIGURATION TOTALS</b>					1,065 lbs

Footprint: 85"w x 102"d x 82"h

Note: 49" Extension Bridge BT4921BR\_ \_ can be substituted to allow more room between the desk and credenza.

- 1/32" veneer is grade "A" Cherry, plain-sliced, bookmatched without knots or objectionable grain distortion.
- All exposed substrate edges are solid cherry hardwood.
- Drawer slides are 100 pound rated, ball bearing slides with full extension.
- All file drawers have central locking mechanisms and feature adaptable rails for letter and legal filing. Lateral file drawers allow front-to-back vertical filing and side-to-side lateral filing.
- Wire management grommets are located on the sides of desks.

**BARITONE • U-Unit 72" Desk – Left Hand Return with Open Bookcase**

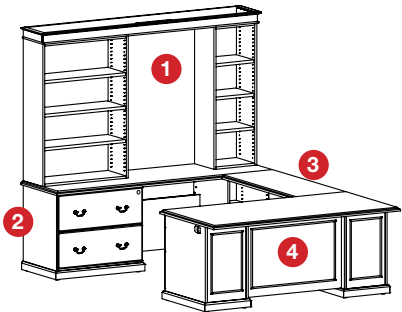

DESCRIPTION	PART NUMBER	WIDTH	DEPTH	HEIGHT	SHIP WGT
1. Upper Bookcase, Double Open Shelves Left, Single Shelves Right with 33" Light Bridge	BT8515BCU2OLB1O_ _	85"	14 1/2"	52"	275 lbs
2. Credenza - 2-Drawer Lateral File on Left Side Open Shelves Right Side	BT8524CR2LKHOC_ _	85"	24"	30"	255 lbs
3. Extension Bridge	BT4221BR_ _	42"	20 3/4"	30"	118 lbs
4. Desk - Single Pedestal with Pencil, Box, File Drawer on Right Side Open Shelves on Left with Center Pencil Drawer	BT7236DKRH_ _	72"	36"	30"	417 lbs
<b>CONFIGURATION TOTALS</b>					1,065 lbs

Footprint: 85"w x 102"d x 82"h

Note: 49" Extension Bridge BT4921BR\_ \_ can be substituted to allow more room between the desk and credenza.

**TO ORDER:**

Select the product number and add finish color.

Finish Color:

- CH = Cherry Finish
- MH = Mahogany Finish
- WN = Walnut Finish

For example: BT6830DKCH

Product # BT6830DK Finish Color - CH = Cherry Finish

Baritone product numbers are comprised of alpha and numeric characters. This number indicates product line, size, product options and finish color.

Note: The workstations presented above are suggestions to show the versatility of the groupings. Each grouping is accompanied by a list of the furniture represented in the drawing. You can make your own plans by using different items listed in this catalog.

Pricing shown is discounted to match GSA. Additional discounting available for large quantities. Contact your sales rep for more information.

Product dimensions shown in approximate inches.

**BARITONE • U-Unit 72" Desk – Right Hand Return with Glass Bookcase**

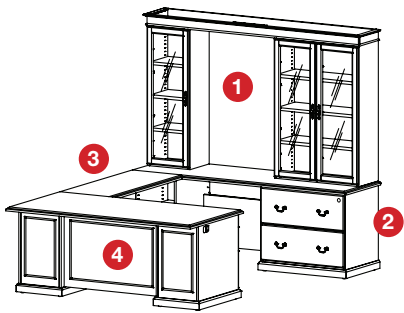

DESCRIPTION	PART NUMBER	WIDTH	DEPTH	HEIGHT	SHIP WGT
1. Upper Bookcase, Double Glass Doors Right, Single Left, with 33" Light Bridge	BT8515BCU1GLB2G_ _	85"	14 1/2"	52"	390 lbs
2. Credenza - 2-Drawer Lateral File on Right Side Open Shelves Left Side	BT8524CROCKH2L_ _	85"	24"	30"	255 lbs
3. Extension Bridge	BT4221BR_ _	42"	20 3/4"	30"	118 lbs
4. Desk - Single Pedestal with Pencil, Box, File Drawer on Left Side Open Shelves on Right with Center Pencil Drawer	BT7236DKLH_ _	72"	36"	30"	417 lbs
<b>CONFIGURATION TOTALS</b>					1,180 lbs

Footprint: 85"w x 102"d x 82"h

Note: 49" Extension Bridge BT4921BR\_ \_ can be substituted to allow more room between the desk and credenza.

- 1/32" veneer is grade "A" Cherry, plain-sliced, bookmatched without knots or objectionable grain distortion.
- All exposed substrate edges are solid cherry hardwood.
- Drawer slides are 100 pound rated, ball bearing slides with full extension.
- All file drawers have central locking mechanisms and feature adaptable rails for letter and legal filing. Lateral file drawers allow front-to-back vertical filing and side-to-side lateral filing.
- Wire management grommets are located on the sides of desks.

**BARITONE • U-Unit 72" Desk – Left Hand Return with Glass Bookcase**

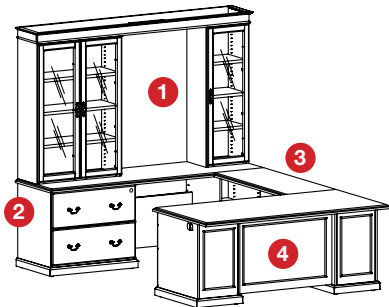

DESCRIPTION	PART NUMBER	WIDTH	DEPTH	HEIGHT	SHIP WGT
1. Upper Bookcase, Double Glass Doors Left, Single Right, with 33" Light Bridge	BT8515BCU2BLBIG_ _	85"	14 1/2"	52"	390 lbs
2. Credenza - 2-Drawer Lateral File on Left Side Open Shelves Right Side	BT8524CR2LKHOC_ _	85"	24"	30"	255 lbs
3. Extension Bridge	BT4221BR_ _	42"	20 3/4"	30"	118 lbs
4. Desk - Single Pedestal with Pencil, Box, File Drawer on Right Side Open Shelves on Left with Center Pencil Drawer	BT7236DKRH_ _	72"	36"	30"	417 lbs
<b>CONFIGURATION TOTALS</b>					1,180 lbs

Footprint: 85"w x 102"d x 82"h

Note: 49" Extension Bridge BT4921BR\_ \_ can be substituted to allow more room between the desk and credenza.

**TO ORDER:**

Select the product number and add finish color.

Finish Color:

- CH = Cherry Finish
- MH = Mahogany Finish
- WN = Walnut Finish

For example: BT6830DKCH

Product # BT6830DK Finish Color - CH = Cherry Finish

Baritone product numbers are comprised of alpha and numeric characters. This number indicates product line, size, product options and finish color.

Note: The workstations presented above are suggestions to show the versatility of the groupings. Each grouping is accompanied by a list of the furniture represented in the drawing. You can make your own plans by using different items listed in this catalog.

Pricing shown is discounted to match GSA. Additional discounting available for large quantities. Contact your sales rep for more information.

Product dimensions shown in approximate inches.

**BARITONE • U-Unit 84" Desk – Left Hand Return with Corner Extension**

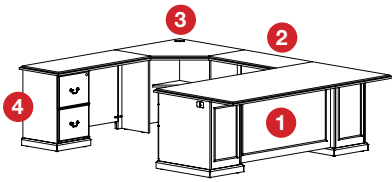

Footprint: 85"w x 114"d x 30"h

DESCRIPTION	PART NUMBER	WIDTH	DEPTH	HEIGHT	SHIP WGT
1. Desk, Single Pedestal Right Hand with Pencil, Box, File Drawer - Open Shelves Left Side with Center Pencil Drawer	BT8442DKRH_ _	84"	42"	30"	513 lbs
2. Extension Bridge	BT3621BR_ _	36"	20 3/4"	30"	103 lbs
3. Corner Unit	BT3636CU_ _	36"	36"	30"	252 lbs
4. Extension Left Hand Return with Pedestal with Two File Drawers	BT4921EXLH_ _	49"	20 3/4"	30"	232 lbs
<b>CONFIGURATION TOTALS</b>					1,100 lbs

- 1/32" veneer is grade "A" Cherry, plain-sliced, bookmatched without knots or objectionable grain distortion.
- All exposed substrate edges are solid cherry hardwood.
- Drawer slides are 100 pound rated, ball bearing slides with full extension.
- All file drawers have central locking mechanisms and feature adaptable rails for letter and legal filing. Lateral file drawers allow front-to-back vertical filing and side-to-side lateral filing.
- Wire management grommets are located on the sides of desks.

**BARITONE • U-Unit 84" Desk – Right Hand Return with Corner Extension**

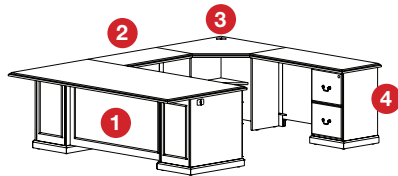

Footprint: 85"w x 114"d x 30"h

DESCRIPTION	PART NUMBER	WIDTH	DEPTH	HEIGHT	SHIP WGT
1. Desk, Single Pedestal Left Hand with Pencil, Box, File Drawer - Open Shelves Right Side with Center Pencil Drawer	BT8442DKLH_ _	84"	42"	30"	513 lbs
2. Extension Bridge	BT3621BR_ _	36"	20 3/4"	30"	118 lbs
3. Corner Unit	BT3636CU_ _	36"	36"	30"	252 lbs
4. Extension Right Hand Return with Pedestal with Two File Drawers	BT4921EXRH_ _	49"	20 3/4"	30"	232 lbs
<b>CONFIGURATION TOTALS</b>					1,100 lbs

**TO ORDER:**

Select the product number and add finish color.

Finish Color:

- CH = Cherry Finish
- MH = Mahogany Finish
- WN = Walnut Finish

For example: BT6830DKCH

Product # BT6830DK Finish Color - CH = Cherry Finish

Baritone product numbers are comprised of alpha and numeric characters. This number indicates product line, size, product options and finish color.

Note: The workstations presented above are suggestions to show the versatility of the groupings. Each grouping is accompanied by a list of the furniture represented in the drawing. You can make your own plans by using different items listed in this catalog.

Pricing shown is discounted to match GSA. Additional discounting available for large quantities. Contact your sales rep for more information.

Product dimensions shown in approximate inches.

## BARITONE • U-Unit 84" Desk – Left Hand Return with Corner Hutch

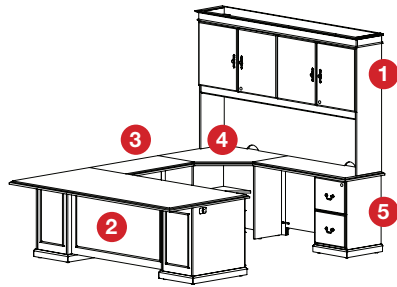

Footprint: 85"w x 114"d x 82"h

DESCRIPTION	PART NUMBER	WIDTH	DEPTH	HEIGHT	SHIP WGT
1. Upper Hutch, Four Solid Doors with 33" Task Light	BT8515HTUS_ _	85"	14 1/2"	52"	375 lbs
2. Desk, Single Pedestal Left Hand with Pencil, Box, File Drawer - Open Shelves Right Side with Center Pencil Drawer	BT8442DKLH_ _	84"	42"	30"	513 lbs
3. Extension Bridge	BT3621BR_ _	36"	20 3/4"	30"	103 lbs
4. Corner Unit	BT3636CU_ _	36"	36"	30"	252 lbs
5. Extension Right Hand Return with Pedestal with Two File Drawers	BT4921EXRH_ _	49"	20 3/4"	30"	232 lbs
<b>CONFIGURATION TOTALS</b>					1,475 lbs

## BARITONE • U-Unit 84" Desk – Right Hand Return with Corner Hutch

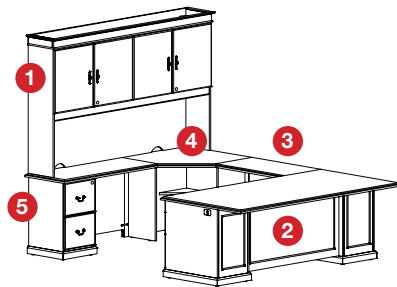

Footprint: 85"w x 114"d x 82"h

DESCRIPTION	PART NUMBER	WIDTH	DEPTH	HEIGHT	SHIP WGT
1. Upper Hutch, Four Solid Doors with 33" Task Light	BT8515HTUS_ _	85"	14 1/2"	52"	375 lbs
2. Desk, Single Pedestal Right Hand with Pencil, Box, File Drawer - Open Shelves Left Side with Center Pencil Drawer	BT8442DKRH_ _	84"	42"	30"	513 lbs
3. Extension Bridge	BT3621BR_ _	36"	20 3/4"	30"	103 lbs
4. Corner Unit	BT3636CU_ _	36"	36"	30"	252 lbs
5. Extension Left Hand Return with Pedestal with Two File Drawers	BT4921EXLH_ _	49"	20 3/4"	30"	232 lbs
<b>CONFIGURATION TOTALS</b>					1,475 lbs

- 1/32" veneer is grade "A" Cherry, plain-sliced, bookmatched without knots or objectionable grain distortion.
- All exposed substrate edges are solid cherry hardwood.
- Drawer slides are 100 pound rated, ball bearing slides with full extension.
- All file drawers have central locking mechanisms and feature adaptable rails for letter and legal filing. Lateral file drawers allow front-to-back vertical filing and side-to-side lateral filing.
- Wire management grommets are located on the sides of desks.

### TO ORDER:

Select the product number and add finish color.

Finish Color:

- CH = Cherry Finish
- MH = Mahogany Finish
- WN = Walnut Finish

For example: BT6830DKCH

Product # BT6830DK Finish Color - CH = Cherry Finish

Baritone product numbers are comprised of alpha and numeric characters. This number indicates product line, size, product options and finish color.

Note: The workstations presented above are suggestions to show the versatility of the groupings. Each grouping is accompanied by a list of the furniture represented in the drawing. You can make your own plans by using different items listed in this catalog.

Pricing shown is discounted to match GSA. Additional discounting available for large quantities. Contact your sales rep for more information.

Product dimensions shown in approximate inches.



## BARITONE • L-Unit 85" Desk – Left Hand Return w/Tooled Wood Leg

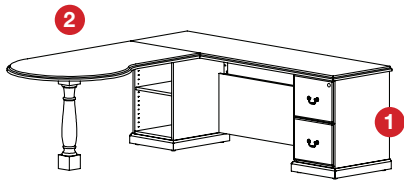

DESCRIPTION	PART NUMBER	WIDTH	DEPTH	HEIGHT	SHIP WGT
1. Credenza - Pedestal with Two File Drawers on Right Side Open Shelves on Left Side	BT8524CROC3KH2F_ _	85"	24"	30"	195 lbs
2. P-Shape Peninsula Conference End Left Hand	BT6136PCXLH_ _	60"	36"	30"	190 lbs
<b>CONFIGURATION TOTALS</b>					385 lbs

Footprint: 85"w x 84"d x 30"h

## BARITONE • L-Unit 85" Desk – Right Hand Return w/Tooled Wood Leg

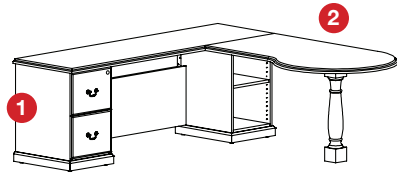

DESCRIPTION	PART NUMBER	WIDTH	DEPTH	HEIGHT	SHIP WGT
1. Credenza - Pedestal with Two File Drawers on Left Side Open Shelves on Right Side	BT8524CR2F3KHOC_ _	85"	24"	30"	195 lbs
2. P-Shape Peninsula Conference End Right Hand	BT6136PCXRH_ _	60"	36"	30"	190 lbs
<b>CONFIGURATION TOTALS</b>					385 lbs

Footprint: 85"w x 84"d x 30"h

- 1/32" veneer is grade "A" Cherry, plain-sliced, bookmatched without knots or objectionable grain distortion.
- All exposed substrate edges are solid cherry hardwood.
- Drawer slides are 100 pound rated, ball bearing slides with full extension.
- All file drawers have central locking mechanisms and feature adaptable rails for letter and legal filing. Lateral file drawers allow front-to-back vertical filing and side-to-side lateral filing.
- Wire management grommets are located on the sides of desks.

### TO ORDER:

Select the product number and add finish color.

Finish Color:

CH = Cherry Finish

MH = Mahogany Finish

WN = Walnut Finish

For example: BT6830DKCH

Product # BT6830DK Finish Color - CH = Cherry Finish

Baritone product numbers are comprised of alpha and numeric characters. This number indicates product line, size, product options and finish color.

Note: The workstations presented above are suggestions to show the versatility of the groupings. Each grouping is accompanied by a list of the furniture represented in the drawing. You can make your own plans by using different items listed in this catalog.

Pricing shown is discounted to match GSA. Additional discounting available for large quantities. Contact your sales rep for more information.

Product dimensions shown in approximate inches.

**BARITONE • L-Unit 85" Desk – Left Hand Return with Tooled Wood Leg and Four Door Hutch**

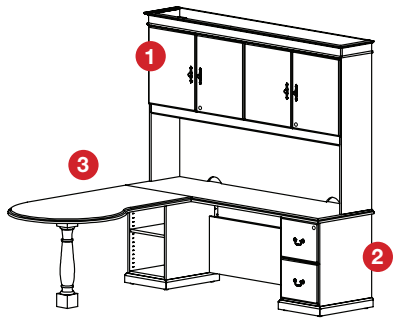

Footprint: 85"w x 84"d x 82"h

DESCRIPTION	PART NUMBER	WIDTH	DEPTH	HEIGHT	SHIP WGT
1. Upper Hutch, Four Solid Doors with 33" Task Light	BT8515HTUS_ _	85"	14 1/2"	52"	375 lbs
2. Credenza - Pedestal with Two File Drawers on Right Side Open Shelves on Left Side	BT8524CROC3KH2F_ _	85"	24"	30"	195 lbs
3. P-Shape Peninsula Conference End Left Hand	BT6136PCXLH_ _	60"	36"	30"	190 lbs
<b>CONFIGURATION TOTALS</b>					<b>760 lbs</b>

- 1/32" veneer is grade "A" Cherry, plain-sliced, bookmatched without knots or objectionable grain distortion.
- All exposed substrate edges are solid cherry hardwood.
- Drawer slides are 100 pound rated, ball bearing slides with full extension.
- All file drawers have central locking mechanisms and feature adaptable rails for letter and legal filing. Lateral file drawers allow front-to-back vertical filing and side-to-side lateral filing.
- Wire management grommets are located on the sides of desks.

**BARITONE • L-Unit 85" Desk – Right Hand Return with Tooled Wood Leg and Four Door Hutch**

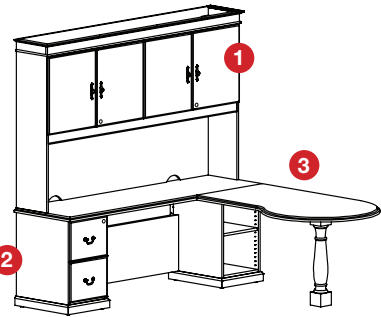

Footprint: 85"w x 84"d x 82"h

DESCRIPTION	PART NUMBER	WIDTH	DEPTH	HEIGHT	SHIP WGT
1. Upper Hutch, Four Solid Doors with 33" Task Light	BT8515HTUS_ _	85"	14 1/2"	52"	375 lbs
2. Credenza - Pedestal with Two File Drawers on Left Side Open Shelves on Right Side	BT8524CR2F3KHOC_ _	85"	24"	30"	195 lbs
3. P-Shape Peninsula Conference End Right Hand	BT6136PCXRH_ _	60"	36"	30"	190 lbs
<b>CONFIGURATION TOTALS</b>					<b>760 lbs</b>

**TO ORDER:**

Select the product number and add finish color.

Finish Color:

- CH = Cherry Finish
- MH = Mahogany Finish
- WN = Walnut Finish

For example: BT6830DKCH

Product # BT6830DK Finish Color - CH = Cherry Finish

Baritone product numbers are comprised of alpha and numeric characters. This number indicates product line, size, product options and finish color.

Note: The workstations presented above are suggestions to show the versatility of the groupings. Each grouping is accompanied by a list of the furniture represented in the drawing. You can make your own plans by using different items listed in this catalog.

Pricing shown is discounted to match GSA. Additional discounting available for large quantities. Contact your sales rep for more information.

Product dimensions shown in approximate inches.

**BARITONE • L-Unit 85" Desk – Left Hand Return with Tooled Wood Leg and Open Shelf Bookcase**

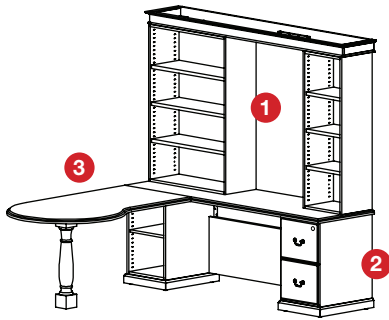

Footprint: 85"w x 84"d x 82"h

DESCRIPTION	PART NUMBER	WIDTH	DEPTH	HEIGHT	SHIP WGT
1. Upper Bookcase Open Shelves Right Side, 33" Light Bridge, Open Shelves Left Side	BT8515BCU2OLB1O_ _	85"	14 1/2"	52"	275 lbs
2. Credenza - Pedestal with Two File Drawers on Right Side Open Shelves on Left Side	BT8524CROC3KH2F_ _	85"	24"	30"	195 lbs
3. P-Shape Peninsula Conference End Left Hand	BT6136PCXLH_ _	60"	36"	30"	190 lbs
<b>CONFIGURATION TOTALS</b>					660 lbs

- 1/32" veneer is grade "A" Cherry, plain-sliced, bookmatched without knots or objectionable grain distortion.
- All exposed substrate edges are solid cherry hardwood.
- Drawer slides are 100 pound rated, ball bearing slides with full extension.
- All file drawers have central locking mechanisms and feature adaptable rails for letter and legal filing. Lateral file drawers allow front-to-back vertical filing and side-to-side lateral filing.
- Wire management grommets are located on the sides of desks.

**BARITONE • L-Unit 85" Desk – Right Hand Return with Tooled Wood Leg and Open Shelf Bookcase**

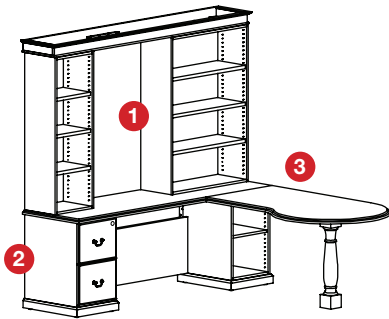

Footprint: 85"w x 84"d x 82"h

DESCRIPTION	PART NUMBER	WIDTH	DEPTH	HEIGHT	SHIP WGT
1. Upper Bookcase Open Shelves Left Side, 33" Light Bridge, Open Shelves Right Side	BT8515BCU1OLB2O_ _	85"	14 1/2"	52"	275 lbs
2. Credenza - Pedestal with Two File Drawers on Left Side Open Shelves on Right Side	BT8524CR2F3KHOC_ _	85"	24"	30"	195 lbs
3. P-Shape Peninsula Conference End Right Hand	BT6136PCXRH_ _	60"	36"	30"	190 lbs
<b>CONFIGURATION TOTALS</b>					660 lbs

**TO ORDER:**

Select the product number and add finish color.

Finish Color:

- CH = Cherry Finish
- MH = Mahogany Finish
- WN = Walnut Finish

For example: BT6830DKCH

Product # BT6830DK Finish Color - CH = Cherry Finish

Baritone product numbers are comprised of alpha and numeric characters. This number indicates product line, size, product options and finish color.

Note: The workstations presented above are suggestions to show the versatility of the groupings. Each grouping is accompanied by a list of the furniture represented in the drawing. You can make your own plans by using different items listed in this catalog.

Pricing shown is discounted to match GSA. Additional discounting available for large quantities. Contact your sales rep for more information.

Product dimensions shown in approximate inches.

## BARITONE • L-Unit 85" Desk – Left Hand Return with Tooled Wood Leg and Glass Door Bookcase

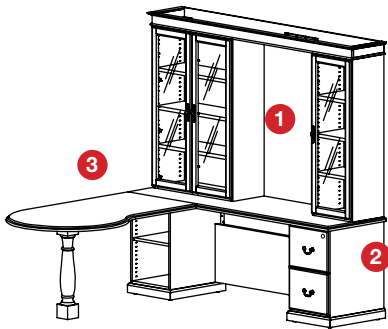

Footprint: 85"w x 84"d x 82"h

DESCRIPTION	PART NUMBER	WIDTH	DEPTH	HEIGHT	SHIP WGT
1. Upper Bookcase, Double Glass Doors Left Side, Single Glass Door Right Side, with 33" Light Bridge	BT8515BCU2GLB1G_ _	85"	14 1/2"	52"	390 lbs
2. Credenza - Pedestal with Two File Drawers on Right Side Open Shelves on Left Side	BT8524CROC3KH2F_ _	85"	24"	30"	195 lbs
3. P-Shape Peninsula Conference End Left Hand	BT6136PCXLH_ _	60"	36"	30"	190 lbs
<b>CONFIGURATION TOTALS</b>					775 lbs

- 1/32" veneer is grade "A" Cherry, plain-sliced, bookmatched without knots or objectionable grain distortion.
- All exposed substrate edges are solid cherry hardwood.
- Drawer slides are 100 pound rated, ball bearing slides with full extension.
- All file drawers have central locking mechanisms and feature adaptable rails for letter and legal filing. Lateral file drawers allow front-to-back vertical filing and side-to-side lateral filing.
- Wire management grommets are located on the sides of desks.

## BARITONE • L-Unit 85" Desk – Right Hand Return with Tooled Wood Leg and Glass Door Bookcase

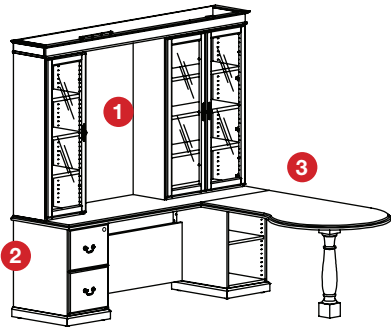

Footprint: 85"w x 84"d x 82"h

DESCRIPTION	PART NUMBER	WIDTH	DEPTH	HEIGHT	SHIP WGT
1. Upper Bookcase, Double Glass Doors Right Side, Single Glass Door Left Side, with 33" Light Bridge	BT8515BCU1GLB2G_ _	85"	14 1/2"	52"	390 lbs
2. Credenza - Pedestal with Two File Drawers on Left Side Open Shelves on Right Side	BT8524CR2F3KHOC_ _	85"	24"	30"	195 lbs
3. P-Shape Peninsula Conference End Right Hand	BT6136PCXRH_ _	60"	36"	30"	190 lbs
<b>CONFIGURATION TOTALS</b>					775 lbs

### TO ORDER:

Select the product number and add finish color.

Finish Color:

- CH = Cherry Finish
- MH = Mahogany Finish
- WN = Walnut Finish

For example: BT6830DKCH

Product # BT6830DK Finish Color - CH = Cherry Finish

Baritone product numbers are comprised of alpha and numeric characters. This number indicates product line, size, product options and finish color.

Note: The workstations presented above are suggestions to show the versatility of the groupings. Each grouping is accompanied by a list of the furniture represented in the drawing. You can make your own plans by using different items listed in this catalog.

Pricing shown is discounted to match GSA. Additional discounting available for large quantities. Contact your sales rep for more information.

Product dimensions shown in approximate inches.

## BARITONE • Desk – Double Pedestal

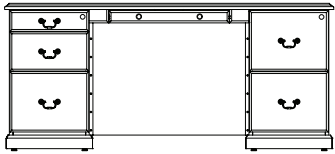

DESCRIPTION	PART NUMBER	WIDTH	DEPTH	HEIGHT	SHIP WGT
Pencil, Box, File Drawers Left Pedestal, Center Pencil Drawer, Two File Drawer Right Pedestal w/ locks with Center Pencil Drawer	BT6830DK_ _	68"	30"	30"	409 lbs

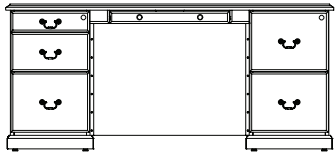

DESCRIPTION	PART NUMBER	WIDTH	DEPTH	HEIGHT	SHIP WGT
Pencil, Box, File Drawers Left Pedestal, Center Pencil Drawer, Two File Drawer Right Pedestal w/ locks with Center Pencil Drawer	BT7236DK_ _	72"	36"	30"	442 lbs
With optional agency seal and approved artwork	BT7236DKSEAL_ _	72"	36"	30"	442 lbs

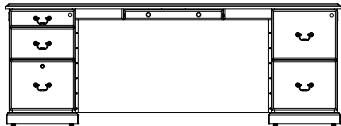

DESCRIPTION	PART NUMBER	WIDTH	DEPTH	HEIGHT	SHIP WGT
Pencil, Box, File Drawers Left Pedestal, Center Pencil Drawer, Two File Drawer Right Pedestal w/ locks with Center Pencil Drawer	BT8442DK_ _	84"	36"	30"	538 lbs
With optional agency seal and approved artwork	BT8442DKSEAL_ _	84"	36"	30"	538 lbs

## BARITONE • Desk – Single Pedestal

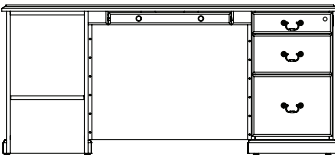

DESCRIPTION	PART NUMBER	WIDTH	DEPTH	HEIGHT	SHIP WGT
Pencil, Box, File Drawer Right Pedestal, Open Shelves Left with Center Pencil Drawer	BT6830DKRH_ _	68"	30"	30"	385 lbs

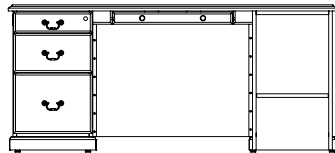

DESCRIPTION	PART NUMBER	WIDTH	DEPTH	HEIGHT	SHIP WGT
Pencil, Box, File Drawer Left Pedestal, Open Shelves Right with Center Pencil Drawer	BT6830DKLH_ _	68"	30"	30"	385 lbs

- 1/32" veneer is grade "A" Cherry, plain-sliced, bookmatched without knots or objectionable grain distortion.
- All exposed substrate edges are solid cherry hardwood.
- Drawer slides are 100 pound rated, ball bearing slides with full extension.
- All file drawers have central locking mechanisms and feature adaptable rails for letter and legal filing. Lateral file drawers allow front-to-back vertical filing and side-to-side lateral filing.
- Wire management grommets are located on the sides of desks.

### TO ORDER:

Select the product number and add finish color.

Finish Color:

CH = Cherry Finish

MH = Mahogany Finish

WN = Walnut Finish

For example: BT6830DKCH

Product # BT6830DK Finish Color - CH = Cherry Finish

Baritone product numbers are comprised of alpha and numeric characters. This number indicates product line, size, product options and finish color.

Pricing shown is discounted to match GSA. Additional discounting available for large quantities. Contact your sales rep for more information.

Product dimensions shown in approximate inches.



## BARITONE • Desk – Single Pedestal

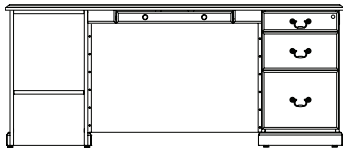

DESCRIPTION	PART NUMBER	WIDTH	DEPTH	HEIGHT	SHIP WGT
Pencil, Box, File Drawer Right Pedestal, Open Shelves Left with Center Pencil Drawer	BT7236DKRH_ _	72"	36"	30"	417 lbs
With optional seal and approved artwork	BT7236DKRHSEAL_ _	72"	36"	30"	417 lbs

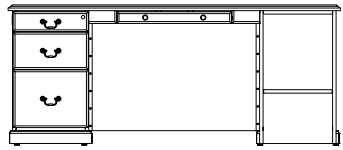

DESCRIPTION	PART NUMBER	WIDTH	DEPTH	HEIGHT	SHIP WGT
Pencil, Box, File Drawer Left Pedestal, Open Shelves Right with Keyboard Tray	BT7236DKLH_ _	72"	36"	30"	417 lbs
With optional seal and approved artwork	BT7236DKLHSEAL_ _	72"	36"	30"	417 lbs

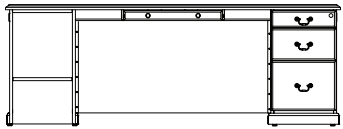

DESCRIPTION	PART NUMBER	WIDTH	DEPTH	HEIGHT	SHIP WGT
Pencil, Box, File Drawer Right Pedestal, Open Shelves Left	BT8442DKRH_ _	84"	42"	30"	513 lbs
With optional seal and approved artwork	BT8442DKRHSEAL_ _	84"	42"	30"	513 lbs

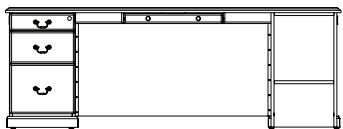

DESCRIPTION	PART NUMBER	WIDTH	DEPTH	HEIGHT	SHIP WGT
Pencil, Box, File Drawer Left Pedestal, Open Shelves Right	BT8442DKLH_ _	84"	42"	30"	513 lbs
With optional seal and approved artwork	BT8442DKLHSEAL_ _	84"	42"	30"	513 lbs

- 1/32" veneer is grade "A" Cherry, plain-sliced, bookmatched without knots or objectionable grain distortion.
- All exposed substrate edges are solid cherry hardwood.
- Drawer slides are 100 pound rated, ball bearing slides with full extension.
- All file drawers have central locking mechanisms and feature adaptable rails for letter and legal filing. Lateral file drawers allow front-to-back vertical filing and side-to-side lateral filing.
- Wire management grommets are located on the sides of desks.

### TO ORDER:

Select the product number and add finish color.

Finish Color:

- CH = Cherry Finish
- MH = Mahogany Finish
- WN = Walnut Finish

For example: BT6830DKCH

Product # BT6830DK Finish Color - CH = Cherry Finish

Baritone product numbers are comprised of alpha and numeric characters. This number indicates product line, size, product options and finish color.

Pricing shown is discounted to match GSA. Additional discounting available for large quantities. Contact your sales rep for more information.

Product dimensions shown in approximate inches.

## BARITONE • Desk – Table



DESCRIPTION	PART NUMBER	WIDTH	DEPTH	HEIGHT	SHIP WGT
Four Legs, with Center Drawer	BT7236TBDK_ _	72"	36"	30"	154 lbs

## BARITONE • Desk – Corner

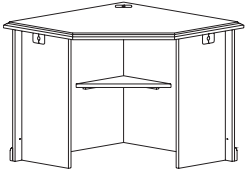

DESCRIPTION	PART NUMBER	WIDTH	DEPTH	HEIGHT	SHIP WGT
Corner Unit Desk - Freestanding	BT3636CU_ _	36"	36"	30"	252 lbs

Note: can be mated to L-Extensions and U-Bridge Extensions

## BARITONE • Desk – Extensions

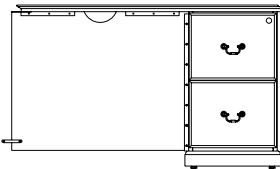

DESCRIPTION	PART NUMBER	WIDTH	DEPTH	HEIGHT	SHIP WGT
L-Extension, Right Return, Pedestal with two file drawers	BT4921EXRH_ _	49"	20 3/4"	30"	232 lbs

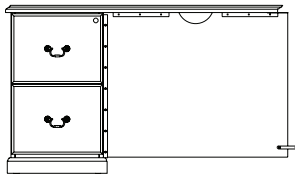

DESCRIPTION	PART NUMBER	WIDTH	DEPTH	HEIGHT	SHIP WGT
L-Extension, Left Return, Pedestal with two file drawers	BT4921EXLH_ _	49"	20 3/4"	30"	232 lbs

- 1/32" veneer is grade "A" Cherry, plain-sliced, bookmatched without knots or objectionable grain distortion.
- All exposed substrate edges are solid cherry hardwood.
- Drawer slides are 100 pound rated, ball bearing slides with full extension.
- All file drawers have central locking mechanisms and feature adaptable rails for letter and legal filing. Lateral file drawers allow front-to-back vertical filing and side-to-side lateral filing.
- Wire management grommets are located on the sides of desks.

### TO ORDER:

Select the product number and add finish color.

Finish Color:

CH = Cherry Finish

MH = Mahogany Finish

WN = Walnut Finish

For example: BT6830DKCH

Product # BT6830DK Finish Color - CH = Cherry Finish

Baritone product numbers are comprised of alpha and numeric characters. This number indicates product line, size, product options and finish color.

Pricing shown is discounted to match GSA. Additional discounting available for large quantities. Contact your sales rep for more information.

Product dimensions shown in approximate inches.

## BARITONE • Desk – U-Extension Bridge

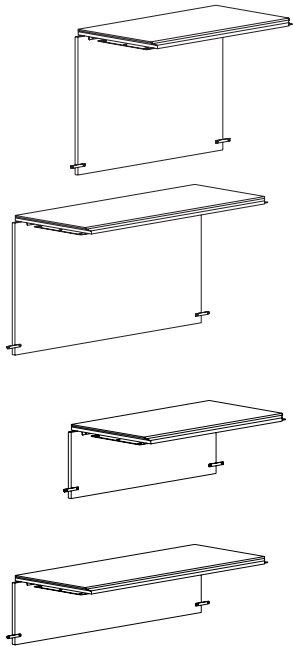

DESCRIPTION	PART NUMBER	WIDTH	DEPTH	HEIGHT	SHIP WGT
<b>U-Extension, Bridge Return Full Modesty</b>	BT3621BR_ _	36"	20 3/4"	30"	103 lbs

Note: can only be used with a corner desk in a U-Shape configuration.

<b>U-Extension, Bridge Return Full Modesty</b>	BT4221BR_ _	42"	20 3/4"	30"	118 lbs
<b>U-Extension, Bridge Return Full Modesty</b>	BT4921BR_ _	49"	20 3/4"	30"	138 lbs

DESCRIPTION	PART NUMBER	WIDTH	DEPTH	HEIGHT	SHIP WGT
<b>U-Extension, Bridge Return Half Modesty</b>	BT3621BRHM_ _	36"	20 3/4"	10 1/4"	103 lbs

Note: can only be used with a corner desk in a U-Shape configuration.

<b>U-Extension, Bridge Return Half Modesty</b>	BT4221BRHM_ _	42"	20 3/4"	10 1/4"	118 lbs
<b>U-Extension, Bridge Return Half Modesty</b>	BT4921BRHM_ _	49"	20 3/4"	10 1/4"	138 lbs

## BARITONE • Desk – Conference Ends

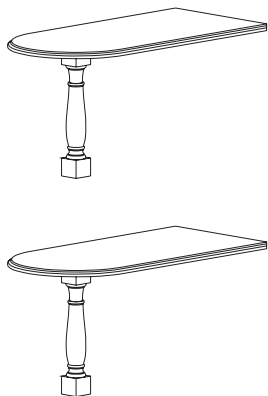

DESCRIPTION	PART NUMBER	WIDTH	DEPTH	HEIGHT	SHIP WGT
<b>Bullet-Shape Peninsula Conference End</b>	BT6030BCX_ _	60"	30"	30"	185 lbs

Note: can fit 84" single pedestal desks and 85" Credenzas with open shelves.

DESCRIPTION	PART NUMBER	WIDTH	DEPTH	HEIGHT	SHIP WGT
<b>Bullet-Shape Peninsula Conference End</b>	BT8436BCX_ _	84"	36"	30"	310 lbs

Note: can fit Credenzas with open shelves.

- 1/32" veneer is grade "A" Cherry, plain-sliced, bookmatched without knots or objectionable grain distortion.
- All exposed substrate edges are solid cherry hardwood.
- Drawer slides are 100 pound rated, ball bearing slides with full extension.
- Wire management grommets are located on the sides of desks.

### TO ORDER:

Select the product number and add finish color.

Finish Color:

- CH = Cherry Finish
- MH = Mahogany Finish
- WN = Walnut Finish

For example: BT6830DKCH

Product # BT6830DK Finish Color - CH = Cherry Finish

Baritone product numbers are comprised of alpha and numeric characters. This number indicates product line, size, product options and finish color.

Pricing shown is discounted to match GSA. Additional discounting available for large quantities. Contact your sales rep for more information.

Product dimensions shown in approximate inches.

## BARITONE • Desk – Conference Ends

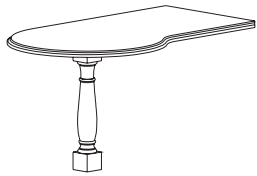

DESCRIPTION	PART NUMBER	WIDTH	DEPTH	HEIGHT	SHIP WGT
<b>P-Shape Peninsula Conference End (Left Hand)</b>	BT6136PCXLH_ _	60"	36"	30"	190 lbs

Note: can fit 84" single pedestal desks and Credenzas with open corners.

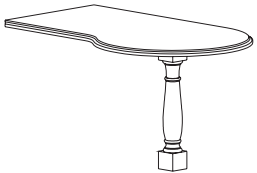

DESCRIPTION	PART NUMBER	WIDTH	DEPTH	HEIGHT	SHIP WGT
<b>P-Shape Peninsula Conference End (Right Hand)</b>	BT6136PCXRH_ _	60"	36"	30"	190 lbs

Note: can fit 84" single pedestal desks and Credenzas with open corners.

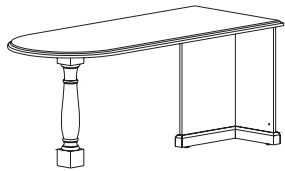

DESCRIPTION	PART NUMBER	WIDTH	DEPTH	HEIGHT	SHIP WGT
<b>Bullet-Shape Peninsula Conference End, Freestanding</b>	BT7230CEDK_ _	72"	30"	30"	240 lbs

## BARITONE • Credenzas

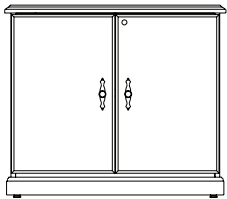

DESCRIPTION	PART NUMBER	WIDTH	DEPTH	HEIGHT	SHIP WGT
<b>Credenza - two doors with central locking mechanism, one adjustable shelf</b>	BT3524CR2DR_ _	35"	24"	30"	179 lbs

- 1/32" veneer is grade "A" Cherry, plain-sliced, bookmatched without knots or objectionable grain distortion.
- All exposed substrate edges are solid cherry hardwood.
- Drawer slides are 100 pound rated, ball bearing slides with full extension.
- Wire management grommets are located on the sides of desks.

### TO ORDER:

Select the product number and add finish color.

Finish Color:

CH = Cherry Finish

MH = Mahogany Finish

WN = Walnut Finish

For example: BT6830DKCH

Product # BT6830DK Finish Color - CH = Cherry Finish

Baritone product numbers are comprised of alpha and numeric characters. This number indicates product line, size, product options and finish color.

Pricing shown is discounted to match GSA. Additional discounting available for large quantities. Contact your sales rep for more information.

Product dimensions shown in approximate inches.

## BARITONE • Credenzas

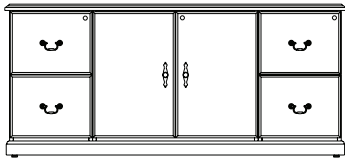

DESCRIPTION	PART NUMBER	WIDTH	DEPTH	HEIGHT	SHIP WGT
Credenza - Two doors and four file drawers	BT6824CR2F2D2F_ _	68"	24"	30"	293 lbs

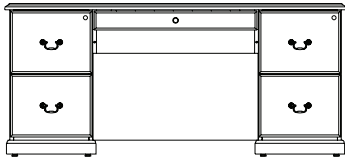

DESCRIPTION	PART NUMBER	WIDTH	DEPTH	HEIGHT	SHIP WGT
Credenza, four file drawers, individual locks, hanging file rods with wire access panel, center keyboard tray.	BT6824CR2FKH2F_ _	68"	24"	30"	229 lbs

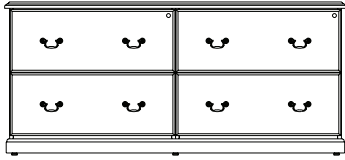

DESCRIPTION	PART NUMBER	WIDTH	DEPTH	HEIGHT	SHIP WGT
Credenza - Four lateral file drawers, individual locks with wire access panel	BT6824CR2L2L_ _	68"	24"	30"	293 lbs

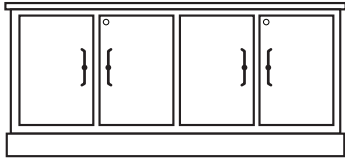

DESCRIPTION	PART NUMBER	WIDTH	DEPTH	HEIGHT	SHIP WGT
Credenza - Double doors with one adjustable shelf each	BT682007_ _	68"	24"	30"	304 lbs

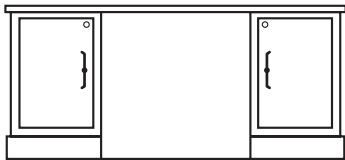

DESCRIPTION	PART NUMBER	WIDTH	DEPTH	HEIGHT	SHIP WGT
Credenza - Single door kneehole with one adjustable shelf each & wire access panel	BT682008_ _	68"	24"	30"	196 lbs

- 1/32" veneer is grade "A" Cherry, plain-sliced, bookmatched without knots or objectionable grain distortion.
- All exposed substrate edges are solid cherry hardwood.
- Drawer slides are 100 pound rated, ball bearing slides with full extension.
- All file drawers have central locking mechanisms and feature adaptable rails for letter and legal filing. Lateral file drawers allow front-to-back vertical filing and side-to-side lateral filing.
- Wire management grommets are located on the sides of desks.

### TO ORDER:

Select the product number and add finish color.

Finish Color:

CH = Cherry Finish

MH = Mahogany Finish

WN = Walnut Finish

For example: BT6830DKCH

Product # BT6830DK Finish Color -

CH = Cherry Finish

Baritone product numbers are comprised of alpha and numeric characters.

This number indicates product line, size, product options and finish color.

Pricing shown is discounted to match GSA. Additional discounting available for large quantities. Contact your sales rep for more information.

Product dimensions shown in approximate inches.



## BARITONE • Credenzas

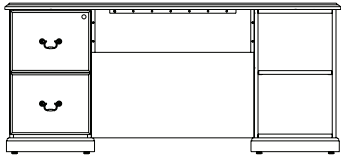

DESCRIPTION	PART NUMBER	WIDTH	DEPTH	HEIGHT	SHIP WGT
<b>Credenza - Two file drawers on left hand side, open shelves right hand side with wire access panel</b>	BT6824CR2FKHOC_ _	68"	24"	30"	205 lbs

Note: can be used only with desk extensions.

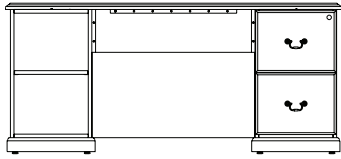

DESCRIPTION	PART NUMBER	WIDTH	DEPTH	HEIGHT	SHIP WGT
<b>Credenza - Two file drawers on right hand side, open shelves left hand side with wire access panel</b>	BT6824CROCKH2F_ _	68"	24"	30"	205 lbs

Note: can be used only with desk extensions.

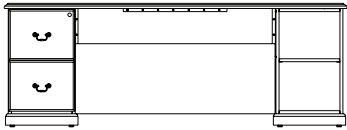

DESCRIPTION	PART NUMBER	WIDTH	DEPTH	HEIGHT	SHIP WGT
<b>Credenza - Two file drawers, left hand side, Open right hand side with wire access panel</b>	BT8524CR2F3KHOC_ _	85"	24"	30"	195 lbs

Note: can be used only with desk extensions.

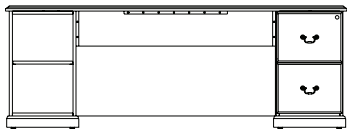

DESCRIPTION	PART NUMBER	WIDTH	DEPTH	HEIGHT	SHIP WGT
<b>Credenza - two files, Right, Open Left Side with wire access panel</b>	BT8524CROC3KH2F_ _	85"	24"	30"	195 lbs

Note: can be used only with desk extensions and conference ends.

- 1/32" veneer is grade "A" Cherry, plain-sliced, bookmatched without knots or objectionable grain distortion.
- All exposed substrate edges are solid cherry hardwood.
- Drawer slides are 100 pound rated, ball bearing slides with full extension.
- All file drawers have central locking mechanisms and feature adaptable rails for letter and legal filing. Lateral file drawers allow front-to-back vertical filing and side-to-side lateral filing.
- Wire management grommets are located on the sides of desks.

### TO ORDER:

Select the product number and add finish color.

Finish Color:

CH = Cherry Finish

MH = Mahogany Finish

WN = Walnut Finish

For example: BT6830DKCH

Product # BT6830DK Finish Color - CH = Cherry Finish

Baritone product numbers are comprised of alpha and numeric characters. This number indicates product line, size, product options and finish color.

Pricing shown is discounted to match GSA. Additional discounting available for large quantities. Contact your sales rep for more information.

Product dimensions shown in approximate inches.

## BARITONE • Credenzas

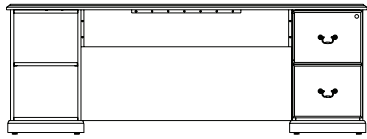

DESCRIPTION	PART NUMBER	WIDTH	DEPTH	HEIGHT	SHIP WGT
<b>Credenza - two files, Right, Open Left Side with wire access panel</b>	BT8524CROC3KH2F_ _	85"	24"	30"	195 lbs

Note: can be used only with desk extensions and conference ends.

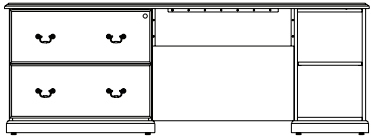

DESCRIPTION	PART NUMBER	WIDTH	DEPTH	HEIGHT	SHIP WGT
<b>Credenza - 2-drawer lateral files on left side, open shelves right side with wire access panel</b>	BT8524CR2LKHOC_ _	85"	24"	30"	255 lbs

Note: can be used only with desk extensions and conference ends.

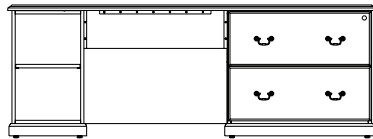

DESCRIPTION	PART NUMBER	WIDTH	DEPTH	HEIGHT	SHIP WGT
<b>Credenza - 2-drawer lateral files on right side, open shelves left side with wire access panel</b>	BT8524CROCKH2L_ _	85"	24"	30"	255 lbs

Note: can be used only with desk extensions.

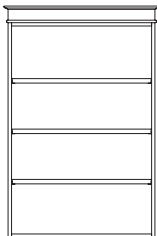

## BARITONE • Upper Bookcases

DESCRIPTION	PART NUMBER	WIDTH	DEPTH	HEIGHT	SHIP WGT
<b>Upper Bookcase - four open shelves, three are adjustable</b>	BT3515BCUO_ _	35"	14 1/2"	54"	164 lbs

- 1/32" veneer is grade "A" Cherry, plain-sliced, bookmatched without knots or objectionable grain distortion.
- All exposed substrate edges are solid cherry hardwood.
- Drawer slides are 100 pound rated, ball bearing slides with full extension.
- All file drawers have central locking mechanisms and feature adaptable rails for letter and legal filing. Lateral file drawers allow front-to-back vertical filing and side-to-side lateral filing.
- Wire management grommets are located on the sides of desks.

### TO ORDER:

Select the product number and add finish color.

Finish Color:

- CH = Cherry Finish
- MH = Mahogany Finish
- WN = Walnut Finish

For example: BT6830DKCH

Product # BT6830DK Finish Color - CH = Cherry Finish

Baritone product numbers are comprised of alpha and numeric characters. This number indicates product line, size, product options and finish color.

Pricing shown is discounted to match GSA. Additional discounting available for large quantities. Contact your sales rep for more information.

Product dimensions shown in approximate inches.

## BARITONE • Upper Bookcases

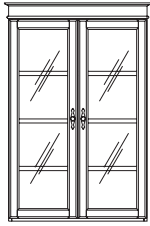

DESCRIPTION	PART NUMBER	WIDTH	DEPTH	HEIGHT	SHIP WGT
Upper Bookcase - two glass doors, four shelves, three are adjustable	BT3515BCUG_ _	35"	14 1/2"	54"	240 lbs

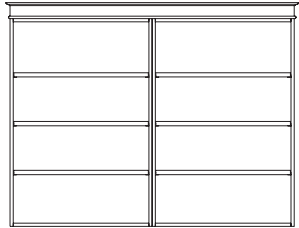

DESCRIPTION	PART NUMBER	WIDTH	DEPTH	HEIGHT	SHIP WGT
Upper Bookcase "Double" - Eight open shelves, six are adjustable	BT6815BCUO_ _	68"	14 1/2"	54"	320 lbs

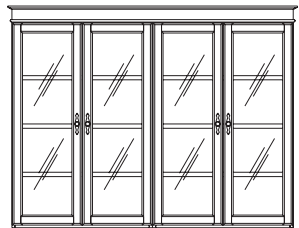

DESCRIPTION	PART NUMBER	WIDTH	DEPTH	HEIGHT	SHIP WGT
Upper Bookcase "Double Glass Doors" - eight shelves, six are adjustable	BT6815BCUG_ _	68"	14 1/2"	54"	472 lbs

- 1/32" veneer is grade "A" Cherry, plain-sliced, bookmatched without knots or objectionable grain distortion.
- All exposed substrate edges are solid cherry hardwood.
- Drawer slides are 100 pound rated, ball bearing slides with full extension.
- Wire management grommets are located on the sides of desks.

### TO ORDER:

Select the product number and add finish color.

Finish Color:

CH = Cherry Finish

MH = Mahogany Finish

WN = Walnut Finish

For example: BT6830DKCH

Product # BT6830DK Finish Color - CH = Cherry Finish

Baritone product numbers are comprised of alpha and numeric characters. This number indicates product line, size, product options and finish color.

Pricing shown is discounted to match GSA. Additional discounting available for large quantities. Contact your sales rep for more information.

Product dimensions shown in approximate inches.

## BARITONE • Upper Bookcases

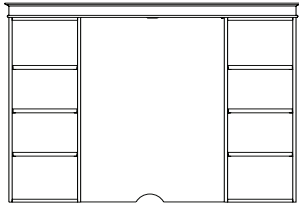

DESCRIPTION	PART NUMBER	WIDTH	DEPTH	HEIGHT	SHIP WGT
Upper Bookcase Open Center - two each 16 1/2" open shelves, 3 adjustable shelves each side with 33" Bridge, with 10-watt halogen down light	BT6815BCUOLBO_ _	68"	14 1/2"	54"	260 lbs

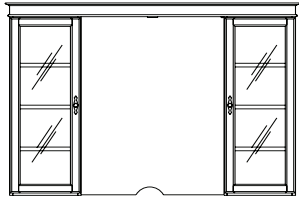

DESCRIPTION	PART NUMBER	WIDTH	DEPTH	HEIGHT	SHIP WGT
Upper Bookcase Open Center - two each 16 1/2" glass doors, three adjustable shelves each side with 33" Bridge, with 10-watt halogen down light	BT6815BCUGLBG_ _	68"	14 1/2"	54"	360 lbs

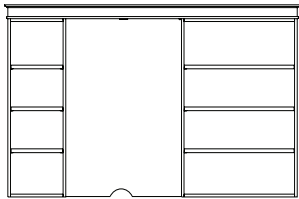

DESCRIPTION	PART NUMBER	WIDTH	DEPTH	HEIGHT	SHIP WGT
Upper Bookcase Open Center - 16 1/2" wide, adjustable open shelves left side, 33" Bridge, with 10-watt halogen down light 33" wide adjustable open shelves right side	BT8515BCU1OLB2O_ _	85"	14 1/2"	54"	275 lbs

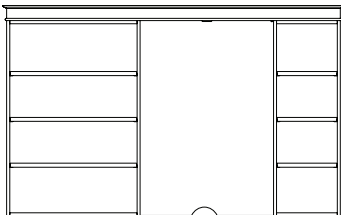

DESCRIPTION	PART NUMBER	WIDTH	DEPTH	HEIGHT	SHIP WGT
Upper Bookcase Open Center - 16 1/2" wide open shelves right side, 33" Bridge, with 10-watt halogen down light 33" wide adjustable open shelves left side	BT8515BCU2OLB1O_ _	85"	14 1/2"	54"	275 lbs

- 1/32" veneer is grade "A" Cherry, plain-sliced, bookmatched without knots or objectionable grain distortion.
- All exposed substrate edges are solid cherry hardwood.
- Drawer slides are 100 pound rated, ball bearing slides with full extension.
- Wire management grommets are located on the sides of desks.

### TO ORDER:

Select the product number and add finish color.

Finish Color:

CH = Cherry Finish

MH = Mahogany Finish

WN = Walnut Finish

For example: BT6830DKCH

Product # BT6830DK Finish Color - CH = Cherry Finish

Baritone product numbers are comprised of alpha and numeric characters. This number indicates product line, size, product options and finish color.

Pricing shown is discounted to match GSA. Additional discounting available for large quantities. Contact your sales rep for more information.

Product dimensions shown in approximate inches.

## BARITONE • Upper Bookcases

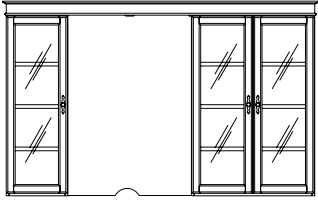

DESCRIPTION	PART NUMBER	WIDTH	DEPTH	HEIGHT	SHIP WGT
Upper Bookcase, One Single 16 1/2" glass door left side, with 33" Bridge, with 10-watt halogen down light, double open glass doors right side (six adjustable shelves)	BT8515BCU1GLB2G_ _	85	14 1/2"	54"	390 lbs

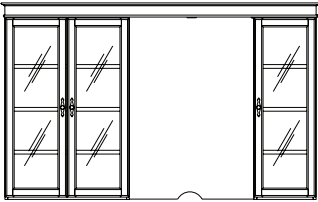

DESCRIPTION	PART NUMBER	WIDTH	DEPTH	HEIGHT	SHIP WGT
Upper Bookcase, One Single 16 1/2" glass door right side, with 33" Bridge, with 10-watt halogen down light, double open glass doors left side (six adjustable shelves)	BT8515BCU2GLB1G_ _	85	14 1/2"	54"	390 lbs

## BARITONE • Upper Hutches

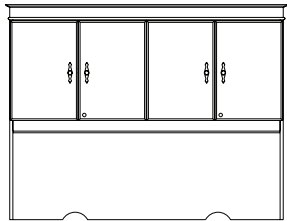

DESCRIPTION	PART NUMBER	WIDTH	DEPTH	HEIGHT	SHIP WGT
Upper Hutch, Four Solid Doors, with two adjustable shelves and Task Light (optional tack board available)	BT6815HTUS_ _	68"	15"	54"	298 lbs
Tack Board Fabric cover: FAB #9246	BT68TKBD3161				15 lbs

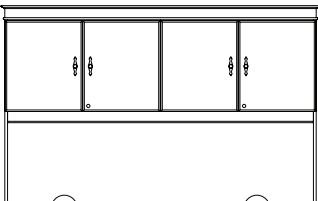

DESCRIPTION	PART NUMBER	WIDTH	DEPTH	HEIGHT	SHIP WGT
Upper Hutch, Four Solid Doors, with two adjustable shelves and Task Light (optional tack board available)	BT8515HTUS_ _	85"	14 1/2"	52"	375 lbs
Tack Board Fabric cover: FAB #9246	BT85TKBD3161				15 lbs

- 1/32" veneer is grade "A" Cherry, plain-sliced, bookmatched without knots or objectionable grain distortion.
- All exposed substrate edges are solid cherry hardwood.
- Drawer slides are 100 pound rated, ball bearing slides with full extension.
- Wire management grommets are located on the sides of desks.

### TO ORDER:

Select the product number and add finish color.

Finish Color:

CH = Cherry Finish

MH = Mahogany Finish

WN = Walnut Finish

For example: BT6830DKCH

Product # BT6830DK Finish Color - CH = Cherry Finish

Baritone product numbers are comprised of alpha and numeric characters. This number indicates product line, size, product options and finish color.

Pricing shown is discounted to match GSA. Additional discounting available for large quantities. Contact your sales rep for more information.

Product dimensions shown in approximate inches.

# BARITONE

## BARITONE • Transaction Counters

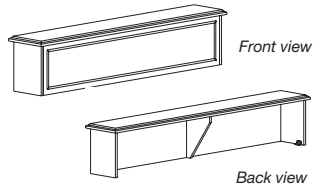

DESCRIPTION	PART NUMBER	WIDTH	DEPTH	HEIGHT	SHIP WGT
Transaction Counter	BT6812TC_ _	68"	12"	14 1/2"	175 lbs

Note: fits any 68" credenza or desk

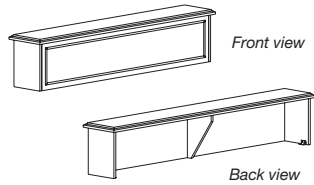

DESCRIPTION	PART NUMBER	WIDTH	DEPTH	HEIGHT	SHIP WGT
Transaction Counter	BT7912TC_ _	78 3/4"	12"	14 1/2"	203 lbs

Note: Fits on a 49" desk extension with a 68" pedestal desk

## BARITONE • Lateral Files

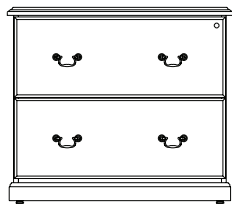

DESCRIPTION	PART NUMBER	WIDTH	DEPTH	HEIGHT	SHIP WGT
2-drawer lateral file, hanging file system	BT3520LF2L_ _	35"	19 3/4"	30 1/2"	205 lbs

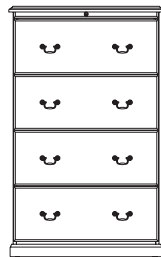

DESCRIPTION	PART NUMBER	WIDTH	DEPTH	HEIGHT	SHIP WGT
4-drawer lateral file, hanging file system (anti-tip system)	BT3520LF4L_ _	35"	19 3/4"	56 1/2"	343 lbs

- 1/32" veneer is grade "A" Cherry, plain-sliced, bookmatched without knots or objectionable grain distortion.
- All exposed substrate edges are solid cherry hardwood.
- Drawer slides are 100 pound rated, ball bearing slides with full extension.
- All file drawers have central locking mechanisms and feature adaptable rails for letter and legal filing. Lateral file drawers allow front-to-back vertical filing and side-to-side lateral filing.
- Wire management grommets are located on the sides of desks.

### TO ORDER:

Select the product number and add finish color.

Finish Color:

- CH = Cherry Finish
- MH = Mahogany Finish
- WN = Walnut Finish

For example: BT6830DKCH

Product # BT6830DK Finish Color - CH = Cherry Finish

Baritone product numbers are comprised of alpha and numeric characters. This number indicates product line, size, product options and finish color.

Pricing shown is discounted to match GSA. Additional discounting available for large quantities. Contact your sales rep for more information.

Product dimensions shown in approximate inches.



## BARITONE • Vertical Files

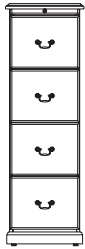

DESCRIPTION	PART NUMBER	WIDTH	DEPTH	HEIGHT	SHIP WGT
<b>4-drawer Vertical File, hanging file system (anti-tip system)</b>	BT1924VF4F_ _	18 1/2"	24"	56 3/4"	260 lbs

\* All file drawers have locks and adaptable rails for letter and legal filing

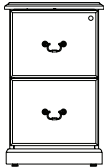

DESCRIPTION	PART NUMBER	WIDTH	DEPTH	HEIGHT	SHIP WGT
<b>2-drawer Vertical File, hanging file system</b>	BT1924VF2F_ _	18 1/2"	24"	30"	130 lbs

## BARITONE • Storage Cabinets

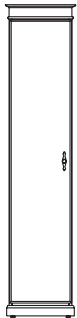

DESCRIPTION	PART NUMBER	WIDTH	DEPTH	HEIGHT	SHIP WGT
<b>Wardrobe Cabinet - four adjustable shelves, with clothes rod and mirror, full front to back hanging with protective rubber mat on inside bottom cabinet</b>	BT1924WD_ _	18 1/2"	24"	82 1/2"	227 lbs



DESCRIPTION	PART NUMBER	WIDTH	DEPTH	HEIGHT	SHIP WGT
<b>Wardrobe Cabinet - double doors, four adjustable shelves with clothes rod, mirror and protective rubber mat on inside bottom cabinet</b>	BT3524WD_ _	35"	24"	82 1/2"	430 lbs

- 1/32" veneer is grade "A" Cherry, plain-sliced, bookmatched without knots or objectionable grain distortion.
- All exposed substrate edges are solid cherry hardwood.
- Drawer slides are 100 pound rated, ball bearing slides with full extension.
- All file drawers have central locking mechanisms and feature adaptable rails for letter and legal filing. Lateral file drawers allow front-to-back vertical filing and side-to-side lateral filing.
- Wire management grommets are located on the sides of desks.

### TO ORDER:

Select the product number and add finish color.

Finish Color:

CH = Cherry Finish

MH = Mahogany Finish

WN = Walnut Finish

For example: BT6830DKCH

Product # BT6830DK Finish Color - CH = Cherry Finish

Baritone product numbers are comprised of alpha and numeric characters. This number indicates product line, size, product options and finish color.

Pricing shown is discounted to match GSA. Additional discounting available for large quantities. Contact your sales rep for more information.

Product dimensions shown in approximate inches.

## BARITONE • Bookcases

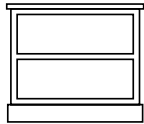

DESCRIPTION	PART NUMBER	WIDTH	DEPTH	HEIGHT	SHIP WGT
<b>Bookcase - 2 shelves (one adjustable shelf)</b>	BT352011_ _	35"	14"	30"	155 lbs

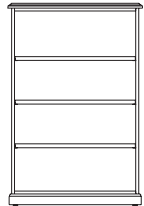

DESCRIPTION	PART NUMBER	WIDTH	DEPTH	HEIGHT	SHIP WGT
<b>Bookcase - four shelves, three adjustable shelves</b>	BT3515BC4SHO_ _	35"	14"	52 1/2"	251 lbs

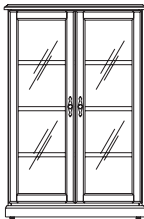

DESCRIPTION	PART NUMBER	WIDTH	DEPTH	HEIGHT	SHIP WGT
<b>Bookcase - four shelves, three adjustable shelves with two glass doors</b>	BT3515BC4SHG_ _	35"	14"	52 1/2"	327 lbs

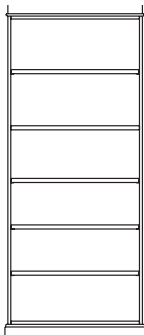

DESCRIPTION	PART NUMBER	WIDTH	DEPTH	HEIGHT	SHIP WGT
<b>Bookcase - six shelves, four adjustable shelves</b>	BT3515BC6SHO_ _	35"	14"	82 1/2"	329 lbs

- 1/32" veneer is grade "A" Cherry, plain-sliced, bookmatched without knots or objectionable grain distortion.
- All exposed substrate edges are solid cherry hardwood.
- Drawer slides are 100 pound rated, ball bearing slides with full extension.
- Wire management grommets are located on the sides of desks.

### TO ORDER:

Select the product number and add finish color.

Finish Color:

- CH = Cherry Finish
- MH = Mahogany Finish
- WN = Walnut Finish

For example: BT6830DKCH

Product # BT6830DK Finish Color - CH = Cherry Finish

Baritone product numbers are comprised of alpha and numeric characters. This number indicates product line, size, product options and finish color.

Pricing shown is discounted to match GSA. Additional discounting available for large quantities. Contact your sales rep for more information.

Product dimensions shown in approximate inches.

## BARITONE • Bookcases

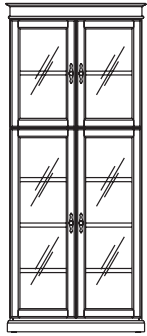

DESCRIPTION	PART NUMBER	WIDTH	DEPTH	HEIGHT	SHIP WGT
Bookcase - six shelves, four adjustable shelves with four glass doors	BT3515BC6SHG_ _	35"	14"	82 1/2"	443 lbs

## BARITONE • Tables

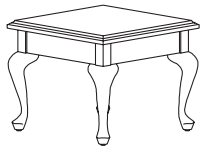

DESCRIPTION	PART NUMBER	WIDTH	DEPTH	HEIGHT	SHIP WGT
Square Table	BT2323OTB_ _	22 1/4"	22 1/4"	17 3/4"	40 lbs

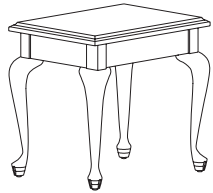

DESCRIPTION	PART NUMBER	WIDTH	DEPTH	HEIGHT	SHIP WGT
Lamp Table	BT2418OTB_ _	24"	18"	22 1/2"	32 lbs

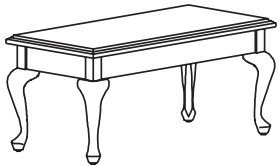

DESCRIPTION	PART NUMBER	WIDTH	DEPTH	HEIGHT	SHIP WGT
Magazine Table	BT4120OTB_ _	40 1/4"	19 1/4"	17 3/4"	52 lbs

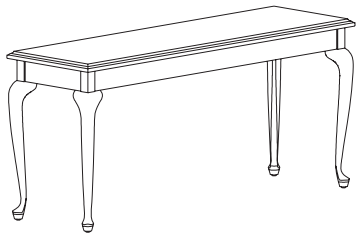

DESCRIPTION	PART NUMBER	WIDTH	DEPTH	HEIGHT	SHIP WGT
Sofa Table	BT6620OTB_ _	66"	20"	29 1/2"	85 lbs

- 1/32" veneer is grade "A" Cherry, plain-sliced, bookmatched without knots or objectionable grain distortion.
- All exposed substrate edges are solid cherry hardwood.
- Drawer slides are 100 pound rated, ball bearing slides with full extension.
- Wire management grommets are located on the sides of desks.

### TO ORDER:

Select the product number and add finish color.

Finish Color:

CH = Cherry Finish

MH = Mahogany Finish

WN = Walnut Finish

For example: BT6830DKCH

Product # BT6830DK Finish Color - CH = Cherry Finish

Baritone product numbers are comprised of alpha and numeric characters. This number indicates product line, size, product options and finish color.

Pricing shown is discounted to match GSA. Additional discounting available for large quantities. Contact your sales rep for more information.

Product dimensions shown in approximate inches.

## BARITONE • Conference Tables

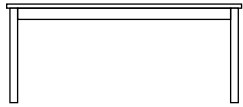

DESCRIPTION	PART NUMBER	WIDTH	DEPTH	HEIGHT	SHIP WGT
6' Conference Table – 4 Leg Base	BT723602_ _	72"	36"	30"	154 lbs

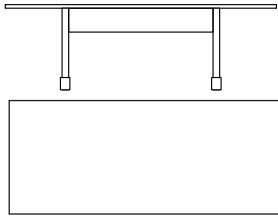

DESCRIPTION	PART NUMBER	WIDTH	DEPTH	HEIGHT	SHIP WGT
8' Conference Table – Panel Base	BT964201_ _	96"	42"	30"	320 lbs

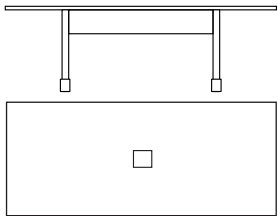

DESCRIPTION	PART NUMBER	WIDTH	DEPTH	HEIGHT	SHIP WGT
8' Conference Table – Panel Base (includes opening for 1 Power/Data Center – see below to order)	BT964201PU_ _	96"	42"	30"	320 lbs

## BARITONE • Conference Tables • Power/Data Center

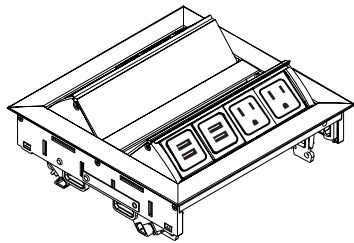

DESCRIPTION	PART NUMBER	WIDTH	LENGTH	SHIP WGT
M2XB Flip-Up, Power/Data Center (includes 4, 3-prong grounded electrical outlets & 8 USB charger ports (includes 10' power cord))	M2XB	7.6875"	8"	15 lbs

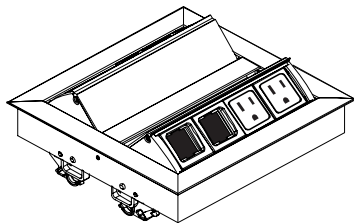

DESCRIPTION	PART NUMBER	WIDTH	LENGTH	SHIP WGT
M2X Flip-Up, Power/Data Center (includes 4, 3-prong grounded electrical outlets & 4 user-configurable simplex ports (includes 10' power cord))	M2X	7.6875"	8"	15 lbs

- 1/32" veneer is grade "A" Cherry, plain-sliced, bookmatched without knots or objectionable grain distortion.
- All exposed substrate edges are solid cherry hardwood.
- Drawer slides are 100 pound rated, ball bearing slides with full extension.
- Two-piece support stretcher accommodates wire management.

### TO ORDER:

Select the product number and add finish color.

Finish Color:

CH = Cherry Finish

MH = Mahogany Finish

WN = Walnut Finish

For example: BT6830DKCH

Product # BT6830DK Finish Color - CH = Cherry Finish

Baritone product numbers are comprised of alpha and numeric characters. This number indicates product line, size, product options and finish color.

Pricing shown is discounted to match GSA. Additional discounting available for large quantities. Contact your sales rep for more information.

Product dimensions shown in approximate inches.

## BARITONE • Conference Tables

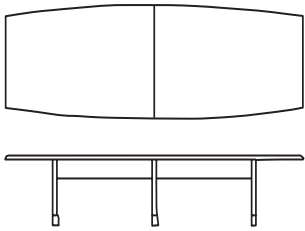

DESCRIPTION	PART NUMBER	WIDTH	DEPTH	HEIGHT	SHIP WGT
<b>10' Boat-Shape Conference Table – Panel Base, Two-Piece Top</b>	BT1204803_ _	120"	48"	30"	320 lbs

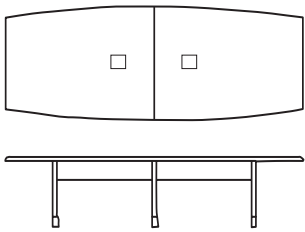

DESCRIPTION	PART NUMBER	WIDTH	DEPTH	HEIGHT	SHIP WGT
<b>10' Boat-Shape Conference Table – Panel Base, Two-Piece Top (includes openings for 2 Power/Data Centers – see page 32 to order)</b>	BT1204803PU_ _	120"	48"	30"	320 lbs

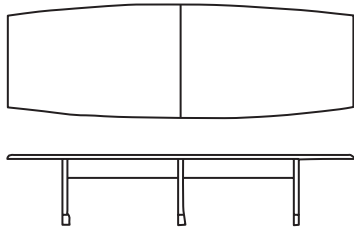

DESCRIPTION	PART NUMBER	WIDTH	DEPTH	HEIGHT	SHIP WGT
<b>12' Boat-Shape Conference Table – Panel Base, Two-Piece Top</b>	BT1444803_ _	144"	48"	30"	384 lbs

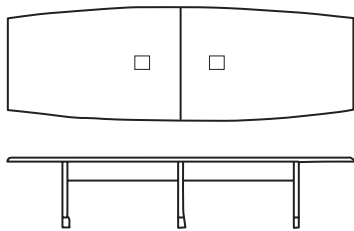

DESCRIPTION	PART NUMBER	WIDTH	DEPTH	HEIGHT	SHIP WGT
<b>12' Boat-Shape Conference Table – Panel Base, Two-Piece Top (includes openings for 2 Power/Data Centers – see page 32 to order)</b>	BT1444803PU_ _	144"	48"	30"	384 lbs

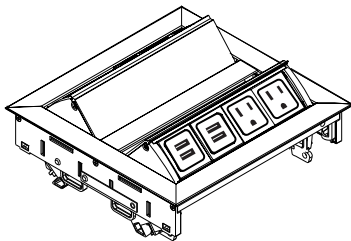

M2XB Flip-up, Power/Data Center (see page 32 to order.)

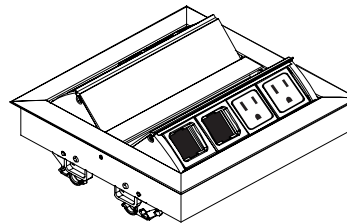

M2X Flip-up, Power/Data Center (see page 32 to order.)

- 1/32" veneer is grade "A" Cherry, plain-sliced, bookmatched without knots or objectionable grain distortion.
- All exposed substrate edges are solid cherry hardwood.
- Drawer slides are 100 pound rated, ball bearing slides with full extension.
- Two-piece support stretcher accommodates wire management.

### TO ORDER:

Select the product number and add finish color.

Finish Color:

CH = Cherry Finish

MH = Mahogany Finish

WN = Walnut Finish

For example: BT6830DKCH

Product # BT6830DK Finish Color -

CH = Cherry Finish

Baritone product numbers are comprised of alpha and numeric characters. This number indicates product line, size, product options and finish color.

Pricing shown is discounted to match GSA. Additional discounting available for large quantities. Contact your sales rep for more information.

Product dimensions shown in approximate inches.

## BARITONE • Conference Tables



DESCRIPTION	PART NUMBER	WIDTH	DEPTH	HEIGHT	SHIP WGT
Conference Table with Four Legs	BT9642RTCTB_ _	96"	42"	30"	320 lbs

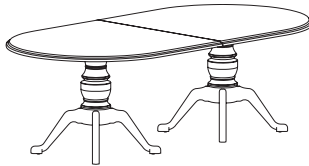

DESCRIPTION	PART NUMBER	WIDTH	DEPTH	HEIGHT	SHIP WGT
Conference Table - Racetrack-Shape (made of two sections, hasp locking) with Queen Anne Base	BT9642XCTB_ _	96"	48"	30"	360 lbs

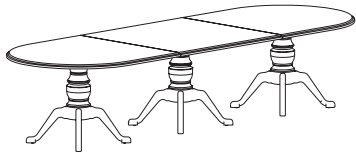

DESCRIPTION	PART NUMBER	WIDTH	DEPTH	HEIGHT	SHIP WGT
Conference Table - Racetrack-Shape, (made of three sections) with Queen Anne Base	BT14442XCTB_ _	144"	48"	30"	540 lbs

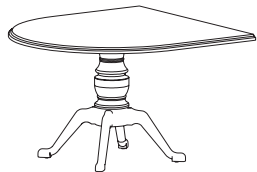

DESCRIPTION	PART NUMBER	WIDTH	DEPTH	HEIGHT	SHIP WGT
Conference Table - Racetrack-Shape, half-round end section, with Queen Anne Base	BT4848XCTBES_ _	48"	48"	30"	180 lbs

Note: Not a stand-alone table. Two half round tables can be ganged together or ganged to both ends of our 4 foot wide square tables (BT4848XCTBMS\_ \_ , see below). Use as many of the square tables to obtain your desired width.

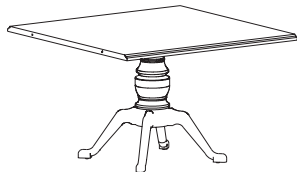

DESCRIPTION	PART NUMBER	WIDTH	DEPTH	HEIGHT	SHIP WGT
Conference Table - Racetrack-Shape, square mid-section, with Queen Anne Base	BT4848XCTBMS_ _	48"	48"	30"	180 lbs

Note: Not a stand-alone table. Must be ganged with at least 2 half round tables (BT4848XCTES\_ \_ , see above). Use as many of these 4 foot wide sections to obtain your desired width.

- 1/32" veneer is grade "A" Cherry, plain-sliced, bookmatched without knots or objectionable grain distortion.
- All exposed substrate edges are solid cherry hardwood.
- Drawer slides are 100 pound rated, ball bearing slides with full extension.

### TO ORDER:

Select the product number and add finish color.

Finish Color:

- CH = Cherry Finish
- MH = Mahogany Finish
- WN = Walnut Finish

For example: BT6830DKCH

Product # BT6830DK Finish Color - CH = Cherry Finish

Baritone product numbers are comprised of alpha and numeric characters. This number indicates product line, size, product options and finish color.

Pricing shown is discounted to match GSA. Additional discounting available for large quantities. Contact your sales rep for more information.

Product dimensions shown in approximate inches.



## BARITONE • Conference Tables

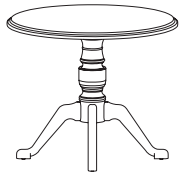

DESCRIPTION	PART NUMBER	WIDTH	DEPTH	HEIGHT	SHIP WGT
Table, 36" Round diameter, with Queen Anne Base	BT36RDTB_ _	36"	30"	30"	122 lbs

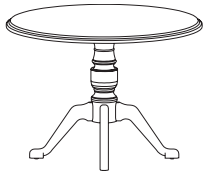

DESCRIPTION	PART NUMBER	WIDTH	DEPTH	HEIGHT	SHIP WGT
Table, 42" Round diameter, with Queen Anne Base	BT42RDTB_ _	42"	30"	30"	141 lbs

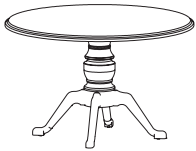

DESCRIPTION	PART NUMBER	WIDTH	DEPTH	HEIGHT	SHIP WGT
Table, 48" Round diameter, with Queen Anne Base	BT48RDTB_ _	48"	48"	30"	160 lbs

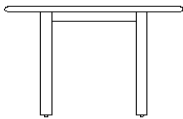

DESCRIPTION	PART NUMBER	WIDTH	DEPTH	HEIGHT	SHIP WGT
Table, 42" Round diameter, with Four Leg Base	BT42R_ _	42"	42"	30"	128 lbs

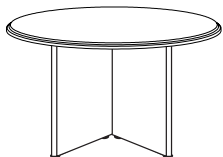

DESCRIPTION	PART NUMBER	WIDTH	DEPTH	HEIGHT	SHIP WGT
Table, 42" Round diameter, with X Leg Base	BT42RX_ _	42"	42"	30"	136 lbs

- 1/32" veneer is grade "A" Cherry, plain-sliced, bookmatched without knots or objectionable grain distortion.
- All exposed substrate edges are solid cherry hardwood.
- Drawer slides are 100 pound rated, ball bearing slides with full extension.

### TO ORDER:

Select the product number and add finish color.

Finish Color:

CH = Cherry Finish

MH = Mahogany Finish

WN = Walnut Finish

For example: BT6830DKCH

Product # BT6830DK Finish Color - CH = Cherry Finish

Baritone product numbers are comprised of alpha and numeric characters. This number indicates product line, size, product options and finish color.

Pricing shown is discounted to match GSA. Additional discounting available for large quantities. Contact your sales rep for more information.

Product dimensions shown in approximate inches.

# BARITONE

## BARITONE • Lecterns

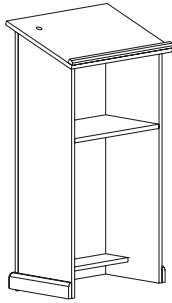

Back view

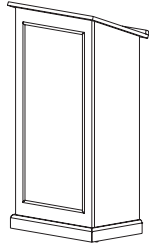

Front view

DESCRIPTION	PART NUMBER	WIDTH	DEPTH	HEIGHT	SHIP WGT
Lectern - Freestanding	BT2517LC_ _	24 1/2"	16 1/4"	47 1/4"	88 lbs
Above with agency seal & approved artwork	BT2517LCSEALB_ _	24 1/2"	16 1/4"	47 1/4"	88 lbs

- 1/32" veneer is grade "A" Cherry, plain-sliced, bookmatched without knots or objectionable grain distortion.
- All exposed substrate edges are solid cherry hardwood.

### TO ORDER:

Select the product number and add finish color.

Finish Color:

- CH = Cherry Finish
- MH = Mahogany Finish
- WN = Walnut Finish

For example: BT6830DKCH

Product # BT6830DK Finish Color - CH = Cherry Finish

Baritone product numbers are comprised of alpha and numeric characters. This number indicates product line, size, product options and finish color.

Pricing shown is discounted to match GSA. Additional discounting available for large quantities. Contact your sales rep for more information.

Product dimensions shown in approximate inches.

## Office Furniture Group • Product Warranty

UNICOR guarantees all furniture products to be free from defect in materials and workmanship. This guarantee applies to the original purchaser of the item and is in effect upon receipt of the item. UNICOR reserves the right to determine whether a UNICOR furniture product is defective in material or workmanship, and whether the below-listed exceptions to the warranty apply. Should UNICOR determine that a UNICOR furniture product is defective in material or workmanship, and no exceptions to the warranty apply, UNICOR will then, at its option, apply one of the following remedies:

1. Issue replacement parts only.
2. Determine that replacement parts and more significant labor may be required, and repair the item.
3. Replace the item.

While we stand behind our commitment to provide the highest quality standards, there is a life expectancy of products based upon normal use, defined as being 40 hours per week by individuals weighing 275 lbs. or less (unless otherwise indicated) and not subjected to abuse, misuse or damage resulting from chemical or environmental exposure. Warranty periods are measured from date of delivery and or installation.

### Warranty Exceptions:

#### a. Missing products

**Delivery shortages** and incorrect shipments must be reported within 15 days of the shipping date.

#### b. Abuse or Misuse of products

While we stand behind our commitment to provide the highest quality standards, products have a life expectancy based on normal use. The Product Warranty does not apply to products subject to abuse, misuse, neglect, alteration, improper or unreasonable use or maintenance, negligence, accident, or exposure to inclement weather conditions.

#### c. Obsolete products with remaining warranty

For furniture items that are no longer in production or their parts are no longer commercially available to support

\* UNICOR seating and furniture product lines carry a 15 year warranty unless otherwise specified.

repair or replacement of in warranty items, customers will be offered either a replacement item or a discount toward the purchase of a comparable item.

### Products have the following warranty, unless otherwise specified in the purchasing agreement:

**Casegoods • High wear components** such as casters, glides, plastic components and locking mechanisms are warranted for 10 years after the date of shipment to original owner.

**Seating • High wear components** such as casters, self-skinned urethane parts, plastic shells and gas cylinders are warranted for 10 years after date of shipment to original owner.

**Seating control mechanisms** are warranted for 10 years after shipment to the original owner.

**Fabric and leather** are warranted for 5 years under normal use and maintenance after shipment to original owner.

**Systems • High wear components** such as slides and locking mechanisms are warranted for 10 years after date of shipment to original owner.

**Electrical components** are warranted for 10 years from the date of manufacture with exception of lamps and ballasts which are not warranted.

**Panel fabrics** are warranted for 5 years under normal use and maintenance to fading after date of shipment to original owner.

**Steel structure components** are warranted against defects for 5 years under normal use after date of shipment to original owner. Warranty does not apply to finishes.

**Ergonomics Accessories • High wear components** such as gas cylinders are warranted for 10 years after date of shipment to original owner.

Any non-standard material (COM/COL materials) selected by the customer is not warranted. Neither does this warranty apply to damage resulting from accident, alteration or misuse, as well as scratches, fading and improper maintenance. OFG assumes no responsibility for product damage resulting from improper

installation, user modification or damage resulting from chemical or environmental exposure.

Wood owes its inherent beauty to variations in color, grain and texture, and therefore these variations are not considered defects. OFG does not guarantee the exact matching of grain, pattern and color to all other office products.

We have taken great care to accurately photographically reproduce finishes for our samples. However there may be variations between the photographic and actual finishes or fabrics. To ensure the fabric selection meets your expectations, please ask your OFG sales representative to provide a sample swatch prior to making your decision.

### Laminate Surfaces and Wood Finishes

1 year warranty on **wood finishes, laminate self edges, veneer tops or molded edge tops**. Laminate and wood finishes are not warranted against the following:

- Damage resulting from unusual environmental conditions (extreme climate, acids and moisture)
- Damage resulting from prolonged exposure to UV light
- Damage resulting from abrasive cleaners
- Damage resulting from improper storage

**Labor and Servicing** cost are covered for 1 year from the shipping date to the original owner.

UNICOR reserves the right to request that the damaged product be returned prior to granting a remedy.

UNICOR offers no other warranty, either expressed or implied, including any warranty of merchantability or fitness for a particular purpose. UNICOR shall not be liable for consequential or incidental damages arising from any product defect.

To initiate a warranty claim, you may call or email Customer Service Center at:

**Email:** [unicorcustomerservice@usdoj.gov](mailto:unicorcustomerservice@usdoj.gov)

**Phone:** 1-800-827-3168

## Terms and Conditions

### The Customer Service Center

Contact the UNICOR/OFG Customer Service Center for any questions or assistance regarding the information in this price list. Our business hours are 7:30 AM to 5:45 PM (EST), Monday through Friday (excluding federal holidays). Our phone number is (800) 827-3168.

### Order Acknowledgment

UNICOR/OFG acknowledges every order. Orders are accepted, filled, and invoiced based on the information in this written order-confirmation. UNICOR/OFG contracts with a third party for services and installation in support of its product(s) on the customer's behalf. Services and installation represent a separate portion of the customer's agreement. Billing will be invoiced upon shipping of product. All other services rendered are subject to payment at completion of each phase, when signed off by the customer. Payment for services and installation is due and payable upon completion of the support services. Should you note any discrepancy, please advise immediately.

Your order acknowledgment indicates a due date when your products will arrive. In the event your products are manufactured earlier than scheduled, we will ship them upon completion, providing that your purchase order states "Early Shipments Authorized."

### Order Modifications

Modification to your purchase order will be accepted up to 6 weeks prior to the due date indicated on your order acknowledgment. However, if the revision results in a change in product availability, a new due date may be set by UNICOR/OFG. Such due date adjustment may be for your full purchase order, whether or not the specifications of all line-items on it are modified. All purchase order modifications are acknowledged in writing, including the annotation of any adjusted due date(s).

Changes requested after we obtain materials for your order may be subject to an upcharge. Confirmation of your order modification will note any such additional charge(s).

### Standard Lead Time

Typical lead time for seating product delivery is 45 days after receipt of your order. However, volume orders having optional finishes or fabrics may take longer, and therefore have an extended due date on your order acknowledgment.

### Product Delivery and Pricing

We take both FOB Origin and FOB Destination orders. All products are shipped via ground transportation.

On FOB Origin orders, title/product-responsibility passes to the customer at the time of shipment. You may arrange your own transportation on FOB Origin orders, coordinating with FPI accordingly. Otherwise, your order will be shipped by common carrier at your expense.

On FOB Destination orders, title/product-responsibility passes to the customer upon delivery to the dock of the designated point-of-delivery.

Freight charges are included in the product prices listed in the FOB Destination column of this price list.

Contact your local UNICOR/OFG Sales Representative for destination prices where none are given. Such destination pricing for delivery outside the continental U.S. must be negotiated based on the freight rates at the time of shipment.

Destination price is the cost of product direct to your loading dock. (NOTE: Freight charges for shipments to Alaska, Hawaii, and overseas destinations are estimated at time of order placement. We will contact you once we obtain a freight quote from our carrier to obtain approval of charges before shipping.)

Installed Price includes installation plus removal of all packing material and trash. (NOTE: If total value at installation prices is under \$1,500, an additional charge may be added to cover the cost of installation.)

Services, such as space-planning/design, storage, inside-delivery and installation is not addressed as part of this price list. Contact your local UNICOR/OFG Sales Representative for such service-fee quotations. To locate your local UNICOR/OFG Sales Representative, go online to [unicor.gov/OFGSalesReps.aspx](http://unicor.gov/OFGSalesReps.aspx)

### Product Pricing Discount

Contact your local UNICOR/OFG Sales Representative for any special agency pricing or volume discounts. To locate your local UNICOR/OFG Sales Representative, go online to [unicor.gov/OFGSalesReps.aspx](http://unicor.gov/OFGSalesReps.aspx)

### Special Packaging

Standard packaging varies per individual product. UNICOR/OFG will accommodate your special packaging requests, however, an upcharge may apply. Contact the Customer Service Center for more information.

### Shipment Claims

UNICOR/OFG products are packed to comply with carrier requirements. All shipments should be inspected by the consignee before acceptance.

The delivering carrier should be requested to record any damage or shortage of items shipped. If any shortages are discovered, please also notify UNICOR/OFG Customer Service Center immediately.

Shipping damage and shortage claims must be filed with the carrier within 7 days of delivery. This applies to both FOB Destination and FOB Origin shipments. Carrier liability ends after 15 days for shipping damages or shortages.

## Terms and Conditions

### Concealed Damage Claims

Claims for concealed damages must be filed with the carrier within 7 days after the delivery of goods. This applies to both FOB Destination and FOB Origin shipments. Carrier liability ends after 15 days for concealed damages.

Neither UNICOR nor the carrier will be responsible for concealed damages if shipments are left unopened and/or claims are not filed within 15 days.

### Product Storage

If necessary, UNICOR/OFG will store products at the factory at no expense to you for a period not to exceed 30 days, if available. Such storage is predicated on the availability of our warehouse space at the time of need.

If UNICOR/OFG storage space is not available, or if you require storage in excess of 30 days, we will assist you in finding commercial storage alternatives at current market rates, at your expense.

### Customer-Delayed Deliveries

Please notify in writing the Customer Service Center at least 2 weeks prior to the confirmed due date when you cannot receive delivery of goods by that scheduled due date. We will delay the delivery at your request. However, after 30 days of such delay, you will be invoiced for the subject products whether or not delivery is extended beyond this first 30 days.

UNICOR/OFG may allow up to 2 weeks for shipping. Therefore, if you do not request delayed delivery at least 2 weeks prior to the confirmed due date for arrival of your shipment, you may incur additional handling costs.

UNICOR/OFG will bill you for such handling costs if you refuse receipt of the goods, or request delayed shipment in less than 2 weeks prior to the due date on your order acknowledgment.

### Product Returns

All product returns must be coordinated in advance with the Customer Service Center. Additionally, all freight or express service charges must be prepaid on return shipments.

Product returns may be subject to being invoiced for additional handling/restocking fees. UNICOR/OFG will determine and notify you of such charges upon receipt and inspection of the returned goods.

### Order Status

Call the Customer Service Center (1-800-827-3168) to obtain status of your order during order processing or the production and shipment/delivery of goods. We will give you the status based on your purchase order number and/or the UNICOR/OFG work order number on your order acknowledgment.

You may also access your order status by clicking on the customer service icon on our website at [www.unicor.gov](http://www.unicor.gov)

### Invoice Payment

Payments from government agencies should be addressed to:

UNICOR - FPI  
P.O. Box 371736  
Pittsburgh PA 15252-7736

Payments from third-party or private sector companies should be addressed to:

UNICOR - LEX  
Accounts Receivable  
P.O. Box 11670  
Lexington KY 40583-3640

All general billing or specific invoice questions should be directed to the

UNICOR Customer Service Center  
1-800-827-3168

